

A NEW SIZE, THAT MOVES

The wheel loaders and telescopic wheel loaders

8155 / 8180 / 8145T



KRAMER
on the safe side



Full efficiency in materials handling

Discover the all wheel steer wheel loaders and telescopic wheel loaders in the 9 to 11-tonne class

Kramer is expanding its broad product portfolio in the wheel loader and telescopic wheel loader segment upwards. The power ratings of the machines are supplemented by the typical Kramer all-wheel steering, which ensures stability, manoeuvrability and compactness. In addition to the impressive performance characteristics, the wheel loaders and telescopic wheel loaders also impress with an innovative, new cabin and operating concept, and are in keeping with the latest technological developments in every respect.



On the safe side with Kramer

Rich in tradition, the Kramer brand has been established on the market for many years and in particular stands for one value: **safety**. The high quality of the innovative machines is only one aspect of this. Kramer is also a safe choice as a company for customers and dealers because its experience and innovations ensure secure investments and security for the future. In short – you are always on the safe side with Kramer: **“Kramer – on the safe side!”**

➔ **ON THE SAFE SIDE**

Table of contents

Vehicle structure

One-piece vehicle frame
Advantages at a glance
Types of steering

04

Machine components and accessories

Attachments
Quickhitch facilities
Loader units

08

Machine highlights at a glance

Engines
Drive
Hydraulics

10

New cab design

Setup
Equipment
Operator's controls

12

Drive train

Drive
Engines

14

Technical data and dimensions

18

Operating and power ratings	8155	8155L
Engine output (optional) [kW]	100 (115)	100 (115)
Bucket capacity [m³]	1.55	1.45
Bucket tipping load [kg]	6,100	5,300
Payload on pallet forks S=1.25 [kg]	4,200	3,800
Operating weight (depends on options) [kg]	9,850	10,250
Operating and power ratings	8180	8180L
Engine output (optional) [kW]	115	115
Bucket capacity [m³]	1.80	1.55
Bucket tipping load [kg]	6,900	5,600
Payload on pallet forks S=1.25 [kg]	4,800	4,000
Operating weight (depends on options) [kg]	11,050	11,220
Operating and power ratings	8145T	
Engine output (optional) [kW]	100 (115)	
Bucket capacity [m³]	1.45	
Bucket tipping load [kg]	5,500	
Payload on pallet forks S=1.25 [kg]	3,900	
Operating weight (depends on options) [kg]	11,170	

Why split what belongs together?

Kramer – A unique system

The Kramer brand stands for all wheel steer loaders, telescopic wheel loaders and telehandlers with extreme manoeuvrability, all-terrain mobility and high efficiency. The wheel loaders and telescopic wheel loaders impress with their high level of stability thanks to the time-tested and proven, undivided vehicle frame.

Due to this special vehicle setup, there is no shifting of the centre of gravity through steering movements. Only the wheels move when steering due to the Ackermann steering. Thus, high stability is given even with a tight turning circle, on uneven ground conditions and with maximum payloads.



The benefits at a glance

High level of stability

The wheel loaders and telescopic wheel loaders are designed with a one-piece chassis that prevents shifts in the centre of gravity – even with a full steering lock. This makes the vehicles with a high level of stability convincing – even in uneven ground conditions.

Enormous manoeuvrability

The all-wheel steering and the steering angle of 40 degrees on the front and rear axle allow you a high degree of manoeuvrability. Some steering manoeuvres therefore become unnecessary, resulting in shorter cycle times.

Constant payload

The undivided chassis prevents the distance between the counterweight and the loader unit from changing. The result: Constant leverage that makes working safe in all load situations. In the process, the payload always stays the same, independent of the steering angle.

Undivided chassis for a high level of stability ...

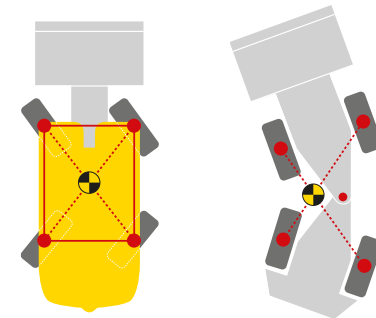

... without a shift in the centre of gravity.

Turning made easy with all-wheel steering ...

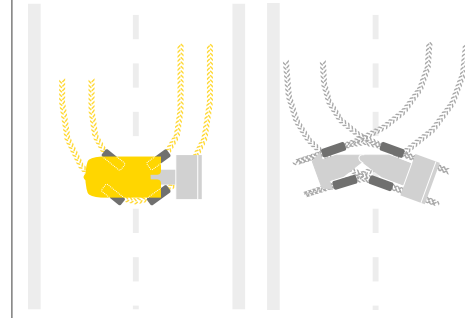

... instead of time-consuming manoeuvring with an articulated joint.

Constant leverage for constant payload

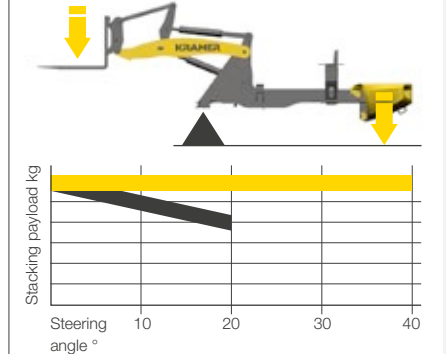

■ Kramer
■ Competition (articulated)

Flexibility in application

The right type of steering system for any application

The undivided vehicle frame forms the basis for three different types of steering. A wheel loader and telescopic wheel loader's design principle decides how it is used and for which application areas. The steering system is the crucial factor here. It is possible to change the steering type while driving Kramer wheel loaders and telescopic wheel loaders.



All-wheel steering

- 2 x 40 degree steering angle on the front and rear axle ensure quick work processes
- Optimised routes
- Tight turning circle



Front wheel steering

- Safe and familiar road travel at high speed
- Easy guidance of special attachments
- Familiar steering system
- Ideal for trailer operation



Crab steering

- Manoeuvrability in the smallest space
- Precise positioning in the tightest conditions
- Moving of special attachments
- Easily move away from walls and trenches



All-wheel steering is particularly manoeuvrable in tight spaces



Front wheel steering ideal for trailer operation



Crab steering for maximum flexibility

A variety of tasks

Always the right attachments

Regardless of what challenges your application holds for you: With the different attachments, you will always have a handle on the situation. Thanks to the hydraulic quickhitch system, you can adapt your Kramer machine to any situation in no time. Standard attachments can even be changed in less than 10 seconds.

The attachment is based on your needs. You can find out more about our attachments at: www.kramer.de/attachments



Noteworthy power

Easily work with big loads

Depending on requirements, different loader units are available to you. The standard loader unit of the 8155 / 8180 has a load-over height of 3.52 m. An extended loader unit, known as the industry loader unit, with 4.03 m load-over height can be optionally ordered, which makes the machines into 8155L / 8180L. The 8145T is equipped with a telescoping loader unit and reaches a load-over height of 5.19 m. Of course an extremely sturdy, hydraulic quickhitch facility is offered here for the harshest applications with a 61.5 mm wide locating pin as well as a 50 mm thick lock pin. All three loader units have the support as per ISO 23727, which is used most frequently worldwide in this performance range.

Standard loader unit (PZ-kinematics) with Kramer quickhitch plate



The PZ mast combines the best of parallel and Z kinematics in one system, thereby guaranteeing a high tearout force and an exact parallel guidance across the entire lifting range.

- Additional overview clearances through underlying tipping cylinders
- High tearout force and parallel guidance across the entire lifting range
- Uniform introduction of force
- Combines the advantages of P and Z-kinematics

Industrial loader unit (P-kinematics) with Kramer quickhitch plate



The P-kinematics impress with a high break out force, high holding forces in the upper range of the mast and exemplary precision when working with heavy loads. This advantage can be felt in particular when loading and unloading as well as stacking with high lift heights.

- Precise and safe work
- Loads are automatically kept level when raising and lowering
- Precise parallel guidance over the entire lift height

Telehandler system (Z-kinematics) with Kramer quickhitch plate



The Z kinematics expand the full-fledged wheel loader to include the advantages of a telescopic wheel loader. The telescopic loader unit allows for greater range and dumping height. Thanks to the high stacking, dumping and load-over height, it is possible to load and unload high-sided trucks.

- Quick dumping and high tear-out forces
- Excellent view of the attachment thanks to the compact design
- Additional reach and dumping width

Machine highlights at a glance

The right machine for a variety of tasks

The wheel loaders and telescopic wheel loaders not only impress with outstanding power ratings despite their low dead weight – but the new design, technical innovation and high quality make them something unique. Your problem solvers for a wide range of tasks and challenges. See for yourself!

The telehandler system with Z kinematics

expands the wheel loader to include the advantages of a telescopic wheel loader. The load-over height is 5.19 m.

The loader unit with P-kinematics

offers a load-over height of 4.03 m with a simultaneously perfect view of the attachment.

The standard loader unit with PZ kinematics

combines high lifting and tearout forces with exact parallel guidance over the entire lifting range and offers a load-over height of 3.52 m.

The powerful load-sensing hydraulics

with 150 l/min (optional 180 l/min) allow for faster work cycles.

Extremely sturdy hydraulic quickhitch facility for the harshest of applications with 61.5 mm centring and lock pins with 50 mm diameter pursuant to ISO 23727.

Drive system with Smart Driving - engine speed reduction at maximum speed.

Unique steering system with three steering modes all-wheel, crab and front wheel steering. This makes the machine extremely manoeuvrable and flexibly equipped for all applications.

The innovatively designed cab design

with ergonomically arranged operator's controls, thanks to its excellent all-round visibility, offers fatigue-free and efficient working. The large LCD display with integrated reverse driving camera, air conditioning and automatic bucket mechanism are only a few features which are part of the standard equipment for the range.

Powerful and efficient Deutz engines of the exhaust emissions stage V

The 8155 and 8145T are driven by a 100 kW Deutz TCD 3.6 engine. The even more powerful Deutz TCD 4.1 engine with 115 kW is optionally available for the machine and is installed in the 8180 as a standard.

The intelligent air guidance, including reversible fan motor, ensures a high cooling performance with little need for maintenance, since no dust is whirled up through the air duct.

EU-wide tractor approval and ball hitch with up to 1 t strut mount

make the wheel loaders and telescopic wheel loaders into optimal tractor units. All common ball hitch systems are available.

Versatile options at the rear

make the loaders perfect all-rounders: inter-alia various hydraulic control circuits, electrical outlet, DIN driving signal socket as well as a compressed air and hydraulic brake.

Driving force newly defined

Increased performance thanks to the newly developed continuously variable hydrostatic transmission, which combines tremendous pushing power with sensitivity.

ecospeedPRO (optional)

Continuously variable hydrostatic transmission for the speed range up to 40 km/h incl. Smart Driving.

Wide range of tire options for a wide range of application areas.

The design principle of the undivided vehicle frame forms the basis for extreme stability, tremendous manoeuvrability and constant payload of the machine. In addition, the operator is offered a wide and safe entry.



Comfortable working area

Everything outside in view

The cab design is completely designed for the operator's comfort and therefore to enhance the operator's performance efficiency. From the operator's seat to the steering wheel, all of the details are consistently aligned with the operator's needs. Ergonomics, driving comfort and functionality are the focus.

The fully glazed cabin is spacious and features considerable headroom and legroom. The dashboard also allows for an optimal unrestricted view of the quickhitch plate. In summary, the cab offers a convenient environment with an excellent all-round visibility for fatigue-free and efficient working, even during long workdays.



Excellent all-round visibility: a narrow cabin struts and panoramic glazing offer an optimal view on all sides.

Technical highlights

Simple operation – Innovative cabin design

Display



The machines are equipped with a completely new operating concept with a large 7-inch LCD display. The setup of the 7" display is simple and intuitive. All important vehicle data and functions are shown in the main menu. The brightness can be regulated and customised to your needs.

Jog Dial



The cabin is equipped with a so-called jog dial. This makes it possible to easily set all important machine settings, such as the oil volume of individual control circuits. The most important operating data can be shown with the rotary and push wheel entirely in line with the operator's requirements.

Armrest



The armrest, including the joystick console and jog dial, is attached to the operator's seat and is equipped with the most important operator's controls. The left hand can therefore remain on the steering wheel while the right hand is in the armrest area. The armrest can be folded up, allowing for exit on the right as well.

Excellent all-round visibility



Large glass surfaces combined with an openly designed glass roof and the integrated reversing camera offer an excellent all-round visibility in the new cabin: an excellent view of the attachment, the immediate working area and the entire machine surroundings.

Cabin entry



The operator's cabin can easily be accessed from both sides via spaciouly designed entry areas via three step-shaped levels. Four grab handles (one on the left of the A-column, two at the step ascent and one on the door) allow for a safe entry and exit on both sides. An interior lighting with a door contact switch is also available.

Other cabin features



The cab design protects the operator from noise emissions (70 dB(A)). In addition, the automatic air conditioning system, work lights and rear window wiper can be controlled on the side above the 7-inch display. Other cabin features include: Bluetooth radio with hands-free equipment, 12 V-outlet with protection cap, two USB connections, and much more.

Variably economical The Kramer high-speed gearbox

The variable hydrostatic high-speed gearbox ecospeedPRO with 45° turning angle of the hydraulic motor was developed together with Kramer. It impresses with maximum economic efficiency combined with the best possible environmental friendliness and excellent driving characteristics.

Thanks to the ecospeedPRO transmission, the speed and pushing power are continuously perfectly coordinated with each other. The new powerful transmission makes continuous acceleration possible from 0 to 40 km/h without shifting. This results in a comfortable uniform driving manner, since there are no tractive force interruptions or shifting jerks.

The ecospeedPRO transmission offers greater tractive force for this machine class than the previous ecospeed. Thus even higher pushing power and tractive forces of up to 10% are achieved.

The machines are equipped with a powerful hydrostat transmission as a standard. The rpm limiter Smart Driving is included as a standard both with the hydrostat version as well as with the ecospeedPRO version.

ecospeed
PRO



Smart Driving

The intelligent engine speed reduction "Smart Driving" optimally adjusts the engine speed at a constant travel speed. At maximum speed, this ensures a reduced noise development and load of the individual elements as well as a lower fuel consumption. Combined with the ecospeedPRO, a reduction of up to 1,550 rpm is possible.

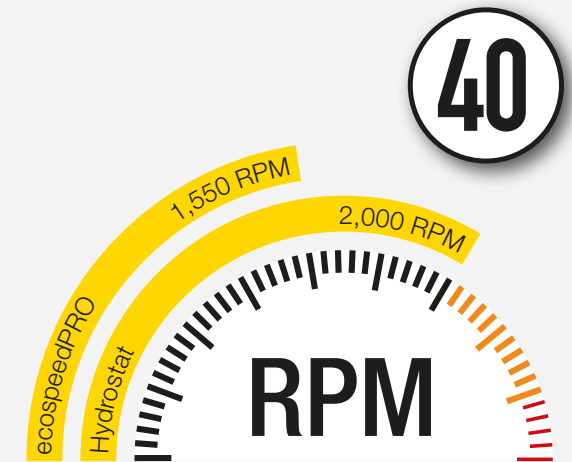

The 7-inch LCD display shows all of the important data.

Three freely selectable speed levels

The speed levels can be easily changed while driving. The change is done conveniently via two touch controls on the joystick and is immediately shown on the 7-inch display with the corresponding symbol (see below). In addition to the three freely selectable driving speeds, different driving modes can optionally be implemented: **Driving with a manual throttle, low-speed control and driving by the accelerator pedal.**



Snail: 0 - 7 km/h

Available with

- Hydrostat
(maximum speed 20 km/h)
- ecospeedPRO
(maximum speed 20, 30 or 40 km/h)

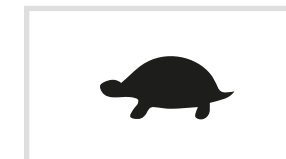

Turtle: 0 - 15 km/h*

Available with

- Hydrostat
(maximum speed 20 km/h)
- ecospeedPRO
(maximum speed 20, 30 or 40 km/h)

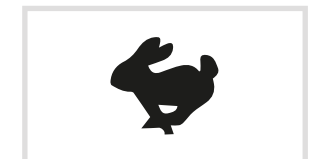

Hare: 0 - 20 (0 - 30 / 0 - 40 km/h)**

Available with

- ecospeedPRO
(maximum speed 20, 30 or 40 km/h)

* 0-20 km/h with high-speed engine

** High-speed engine

Powerful engines

For any application with reduced consumption

The 8155 and 8145T are driven by a 100 kW Deutz TCD 3.6 L4 engine. The even more powerful Deutz TCD 4.1 L4 engine with 115 kW is optionally available for both machines and is installed in the 8180 as standard. Both engines meet the exhaust emission stage V. Furthermore, the exhaust after-treatment occurs via DOC, DPF and SCR.



Water-cooled 4-cylinder in-line engine with cooled external exhaust gas return, turbocharging and intercooling.

Deutz TCD 3.6 L4 performance curve

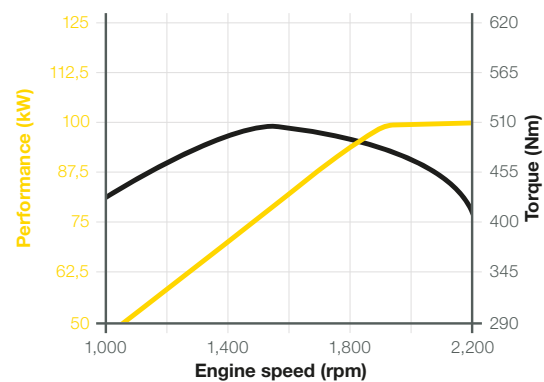

Deutz TCD 4.1 L4 performance curve

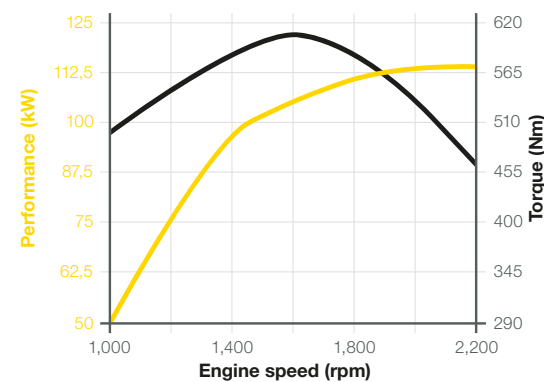

Kramer wheel loaders and telescopic wheel loaders at a glance

Intuitive

- Spacious, ergonomic cabin
- All important information is summarised centrally on the 7" LCD display
- Intuitive machine settings of all operating data through the turn-push instrument
- The rear view camera image is shown directly on the display

Comfortable

- Ergonomically arranged operator's controls - the switches are colour-coded and grouped into functional groups
- All important switches are located in the immediate vicinity of the right hand
- Excellent 360° all-round visibility due to the fully glazed cabin and an open design glass roof
- Convenient entrance and exit on both sides is possible

Intelligent

- Thanks to Smart Loading, the attachment moves back into a previously stored position at the push of a button, making fast work cycles possible
- Smart Driving reduces the engine speed automatically: this is more gentle on the machine and you save fuel
- Maximum versatility due to three speed versions: 20, 30 and 40 km/h
- Three forward and three reverse operation levels are possible

Versatile

- All-wheel steering with 2 x 40° steering lock means the smallest turning radius in the smallest area
- The front wheel steering ensures safe driving in road traffic
- The crab steering allows for parallel travel toward/away from obstacles
- Different loader units and quickhitch systems make the machines versatile in use

Strong

- High torque and economical engines from Deutz
- The powerful load-sensing work hydraulics provide quick work cycles
- Accelerate from 0-40 km/h with the ecospeedPRO transmission completely variably and without shifting and tractive force interruptions
- The cooling system remains clean thanks to the redesigned ventilation concept

Technical Data

Engine	Unit	8155	8155L	8180	8180L	8145T
Make	-	Deutz	Deutz	Deutz	Deutz	Deutz
Model/design system (optional)	-	TCD 3.6 L4 (TCD 4.1 L4)	TCD 3.6 L4 (TCD 4.1 L4)	TCD 4.1 L4	TCD 4.1 L4	TCD 3.6 L4 (TCD 4.1 L4)
Output (optional)	kW	100 (115)	100 (115)	115	115	100 (115)
Max. torque (optional engine)	Nm at rpm	500 Nm at 1,600 rpm (609 Nm at 1,600 rpm)	500 Nm at 1,600 rpm (609 Nm at 1,600 rpm)	609 Nm at 1,600 rpm	609 Nm at 1,600 rpm	500 Nm at 1,600 rpm (609 Nm at 1,600 rpm)
Displacement (optional)	cm ³	3,621 (4,038)	3,621 (4,038)	4,038	4,038	3,621 (4,038)
Exhaust emission stag (LRC - less regulated countries)	-	EU stage V / US EPA Tier 4 (EU stage IIIA / US EPA Tier 3)	EU stage V / US EPA Tier 4 (EU stage IIIA / US EPA Tier 3)	EU stage V / US EPA Tier 4	EU stage V / US EPA Tier 4	EU stage V / US EPA Tier 4 (EU stage IIIA / US EPA Tier 3)
Exhaust after-treatment	-	DOC + DPF + SCR	DOC + DPF + SCR	DOC + DPF + SCR	DOC + DPF + SCR	DOC + DPF + SCR
Power transmission	Unit	Automotive continuously variable, hydrostatic axial piston drive				
Drive	-	Automotive continuously variable, hydrostatic axial piston drive				
Speed (optional)	km/h	0-20 (0-30 / 0-40)	0-20 (0-30 / 0-40)	0-20 (0-30 / 0-40)	0-20 (0-30 / 0-40)	0-20 (0-30 / 0-40)
Axles	-	Planetary steering axles				
Total oscillation angle	°	24	24	24	24	24
Differential lock	%	100% front axle + 100% rear axle	100% front axle + 100% rear axle	100% front axle + 100% rear axle	100% front axle + 100% rear axle	100% front axle + 100% rear axle
Service brake	-	20 km/h: Hydraulic, 1-circuit power brake (FA, lamellas), also acting on the RA via the universal joint shaft. 30 & 40 km/h: Hydraulic 2-circuit external power brake (VA + HA, lamellas)				
Parking brake	-	20, 30, 40 km/h: Electro-hydraulic multi-disc brake with spring accumulator in the front axle, also acting on the rear axle via the universal joint shaft				
Standard tyres	-	500/70R24 Michelin BIBLOAD				
Steering and work hydraulics	Unit	Hydrostatic all-wheel steering, front wheel steering, crab steering with emergency steering features				
Functionality	-	Hydrostatic all-wheel steering, front wheel steering, crab steering with emergency steering features				
Steering pump	-	Gear pump via priority valve				
Steering cylinder	-	1 steering cylinder per axle / electronically synchronising				
Steering lock max.	°	2 x 40	2 x 40	2 x 40	2 x 40	2 x 40
Work pump	-	Variable displacement pump (load-sensing)				
Max. flow rate of pump	l/min	150	150	180	180	150
Max. flow rate of pump option	l/min	180	180	-	-	180
Max. pressure	bar	250	250	250	250	250
Quickhitch system	-	Receptacle as per ISO 23727 / hydraulic locking				

Technical Data

Kinematics	Unit	8155	8155L	8180	8180L	8145T
Design system	-	PZ-kinematics	P-kinematics	PZ-kinematics	P-kinematics	Z-kinematics
Lift capacity	kN	65	68	65	68.5	50
Tearout force	kN	61.9	69.7	54.1	61	79.8
Lift cylinder raising/lowering	s	6.3 / 5.7	6.6 / 4.1	6.3 / 5.7	6.6 / 4.1	6.0 / 4.0
Tilt in tipping cylinder (upper / lower position of the loader unit) // Empty tipping cylinder (upper / lower position of the loader unit)	s	2.4 / 1.9 // 4.0 / 0.8	2.7 / 1.2 // 2.7 / 1.4	2.4 / 1.9 // 4.0 / 0.8	2.7 / 1.2 // 2.7 / 1.4	3.7 / 1.8 // 1.7 / 0.8
Tilt-in / tilt-out angle	°	45 / 45	48 / 45	45 / 45	48 / 45	43 / 40
Capacities	Unit	140 / 125 / 12				
Fuel / hydraulic / DEF tank	l	140 / 125 / 12	140 / 125 / 12	140 / 125 / 12	140 / 125 / 12	140 / 125 / 12
Electrical system	Unit	12				
Operating voltage	V	12	12	12	12	12
Battery / alternator standard TCD L4	Ah/A	185 / 120	185 / 120	-	-	185 / 120
Battery / alternator with optional engine TCD 4.1 L4	Ah/A	185 / 150	185 / 150	185 / 150	185 / 150	185 / 150
Starter motor standard TCD 3.6 L4	kW	3.2	3.2	-	-	3.2
Starter motor with optional motor TCD 4.1 L4	kW	4.0	4.0	4.0	4.0	4.0
Noise emissions*	Unit	101				
Measured value	dB(A)	101	101	101	101	101
Guaranteed value	dB(A)	102	102	102	102	102
Noise level at the operator's ear	dB(A)	70	70	70	70	70
Vibrations**	Unit	m/s ²				
Vibration total value for upper extremities of the body	m/s ²	< 2.5 m/s ² (< 8.2 feet/s ²)				
Highest effective value of weighted acceleration for the body	m/s ²	< 0.5 m/s ² (< 1.64 feet/s ²)*** 1.28 m/s ² (4.19 feet/s ²)****				





* Information: The measurement occurs as per the requirements of the standard EN 474 and the directive 2000/14/EC. Measuring station: Paved surface.





*** On flat and solid ground with the corresponding driving style





**** Application in extraction under harsh environmental conditions

** Uncertainty of measurement such as stated in ISO/TR 25398:2006. Please instruct or inform the operator of possible dangers caused by vibrations.

Technical Data

Standard loader unit	Unit	Standard with teeth	Standard without teeth	Light goods	Super light goods	Power grab bucket
						
Bucket capacity 8155 / 8180	m ³	1.55 / 1.80	1.60 / 1.90	2.05 / 2.50	2.90 / 3.50	1.45 / 1.70
Material density 8155 / 8180	t/m ³	1.80 / 1.80	1.70 / 1.60	1.30 / 1.20	0.75 / 0.80	1.80 / 1.80
Total length 8155 / 8180	mm	6,450 / 6,550	6,370 / 6,475	6,530 / 6,615	6,700 / 6,800	6,470 / 6,503
Bucket width 8155 / 8180	mm	2,500 / 2,500	2,500 / 2,500	2,500 / 2,500	2,500 / 2,500	2,525 / 2,525
Bucket pivot point 8155 / 8180	mm	3,760 / 3,760	3,760 / 3,760	3,760 / 3,760	3,760 / 3,760	3,760 / 3,760
Load-over height 8155 / 8180	mm	3,520 / 3,520	3,495 / 3,495	3,510 / 3,510	3,515 / 3,515	3,515 / 3,515
Dumping height 8155 / 8180	mm	2,725 / 2,695	2,805 / 2,700	2,645 / 2,600	2,470 / 2,425	2,700 / 2,845
Dumping width 8155 / 8180	mm	1,085 / 1,172	970 / 1,070	1,150 / 1,215	1,320 / 1,665	1,134 / 1,340
Digging depth 8155 / 8180	mm	150 / 150	175 / 175	160 / 160	155 / 155	155 / 155
Operating weight 8155 / 8180	kg	9,850 / 11,050	9,930 / 11,080	9,880 / 11,200	9,950 / 11,280	10,090 / 11,300

Industry loader unit	Unit	Standard with teeth	Standard without teeth	Lightweight material	Super light goods	Power grab bucket
						
Bucket capacity 8155L / 8180L	m ³	1.45 / 1.55	1.40 / 1.60	1.75 / 2.10	2.45 / 3.50	1.45 / 1.45
Material density 8155L / 8180L	t/m ³	1.80 / 1.80	1.80 / 1.80	1.30 / 1.20	0.90 / 0.80	1.60 / 1.80
Total length 8155L / 8180L	mm	6,970 / 6,995	6,960 / 6,925	7,110 / 7,120	7,240 / 7,300	7,075 / 7,040
Bucket width 8155L / 8180L	mm	2,500 / 2,500	2,500 / 2,500	2,500 / 2,500	2,500 / 2,500	2,525 / 2,525
Bucket pivot point 8155L / 8180L	mm	4,200 / 4,200	4,200 / 4,200	4,200 / 4,200	4,200 / 4,200	4,200 / 4,200
Load-over height 8155L / 8180L	mm	4,025 / 4,025	3,925 / 4,010	3,935 / 3,990	3,945 / 3,995	3,930 / 4,050
Dumping height 8155L / 8180L	mm	3,237 / 3,210	3,245 / 3,280	3,095 / 3,085	2,960 / 2,835	3,100 / 3,165
Dumping width 8155L / 8180L	mm	1,292 / 1,300	1,160 / 1,190	1,320 / 1,380	1,460 / 1,650	1,310 / 1,385
Digging depth 8155L / 8180L	mm	90 / 160	180 / 180	165 / 165	165 / 165	170 / 170
Operating weight 8155L / 8180L	kg	10,840 / 11,220	10,920 / 11,300	10,870 / 11,400	10,950 / 11,500	11,100 / 11,410

Telescopic loader unit 8145T	Unit	Standard with teeth	Standard without teeth	Lightweight material	Super light goods	Power grab bucket
						
Bucket capacity	m ³	1.45	1.50	2.05	2.90	1.35
Material density	t/m ³	1.80	1.80	1.30	0.90	1.80
Total length	mm	7,020	6,940	7,055	7,225	7,060
Bucket width	mm	2,500	2,500	2,500	2,500	2,525
Bucket pivot point (retracted and extended)	mm	4,285 / 5,425	4,285 / 5,425	5,425	5,425	4,285 / 5,425
Load-over height (retracted and extended)	mm	4,045 / 5,185	4,020 / 5,160	4,070 / 5,240	4,075 / 5,245	4,020 / 5,160
Dumping height (retracted and extended)	mm	3,330 / 4,470	3,445 / 4,585	3,275 / 4,450	3,120 / 4,295	3,270 / 4,410
Dumping width (retracted and extended)	mm	1,255 / 1,685	1,115 / 1,545	1,320 / 1,755	1,510 / 1,950	1,295 / 1,725
Digging depth (retracted and extended)	mm	150	189	130	125	180
Operating weight	kg	11,170	11,220	11,250	11,310	11,420

Technical Data

8155L / 8180L Extended loader unit

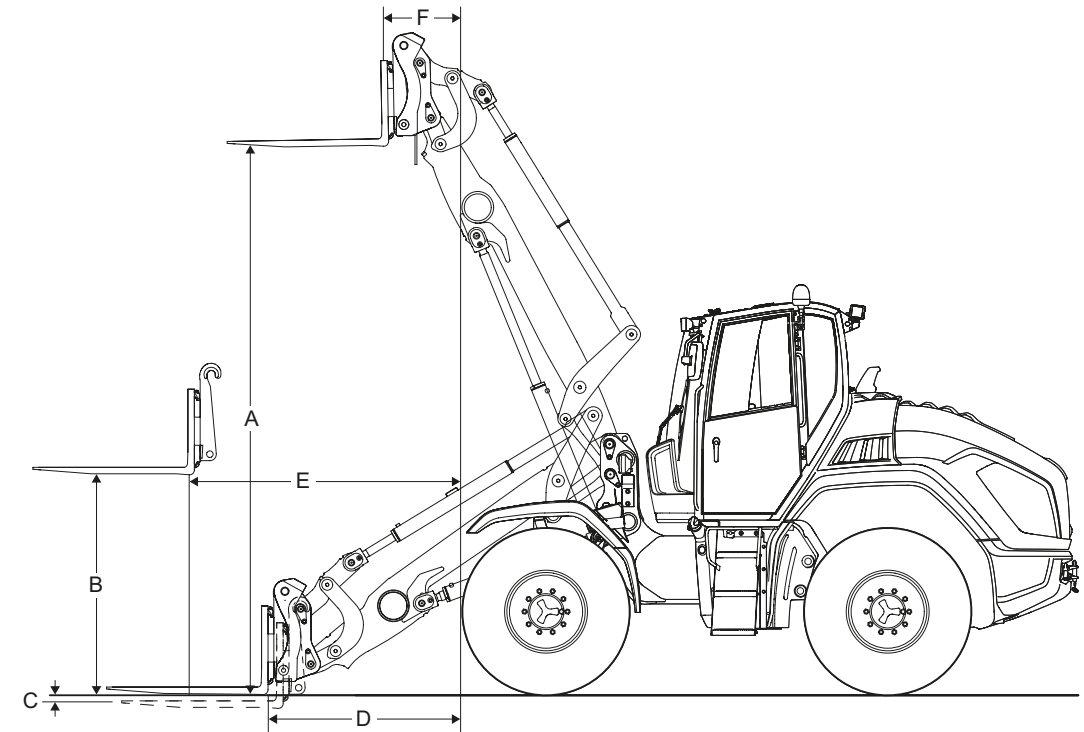

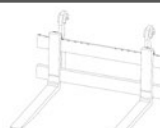
Pallet fork (load centre 500 mm)	Unit	8155	8155L	8180	8180L	8145T
						
-	Width of the fork carriage	mm	1,500	1,500	1,500	1,500
-	Length of the fork tines	mm	1,200	1,200	1,200	1,200
-	Tipping load of pallet fork	kg	5,250	4,750	6,000	5,800
-	Stacking payload S=1.25	kg	4,200	3,800	4,800	4,000
-	Stacking payload S=1.67	kg	3,140	2,850	3,600	3,000
A	Stacking height	mm	3,605	4,055	3,605	4,055
B	Lift height, mast horizontal	mm	1,745	1,745	1,745	1,745
C	Scraping depth	mm	56	56	56	56
D	Ground reach	mm	770	1,465	770	1,465
E	Reach, mast horizontal	mm	1,580	2,090	1,580	2,090
F	Reach at max. height	mm	705	955	705	955

Dimensions*

8155 / 8180 Standard loader unit

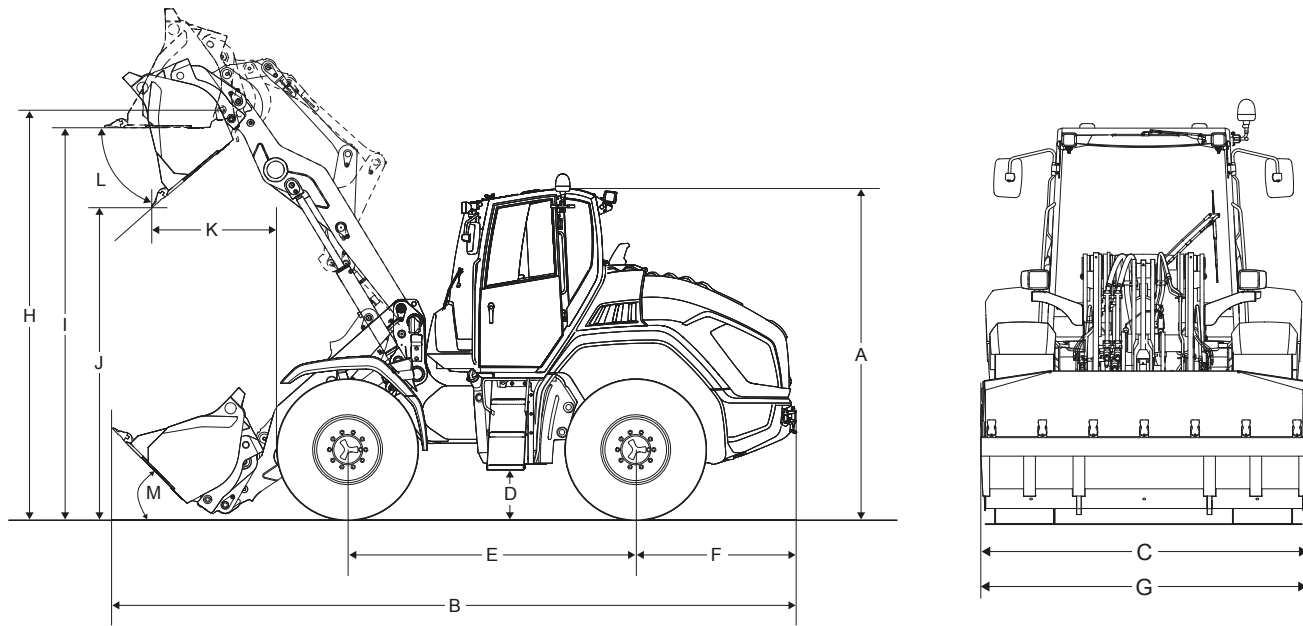

	Unit	8155	8155L	8180	8180L	8145T
A	Height	mm	3,060	3,060	3,060	3,060
B	Length	mm	6,450	7,040	6,550	7,040
C	Width	mm	2,500	2,500	2,500	2,500
D	Ground clearance	mm	445	445	445	445
E	Wheel base	mm	2,620	2,620	2,620	2,620
F	Centre of rear axle to end of vehicle	mm	1,520	1,520	1,520	1,520
G	Bucket width	mm	2,500	2,500	2,500	2,500
H	Bucket swivel point	mm	3,760	4,200	3,760	4,200
I	Load-over height	mm	3,520	4,025	3,520	3,950
J	Dumping height	mm	2,725	3,165	2,695	3,210
K	Dump reach	mm	1,085	1,275	1,172	1,300
L	Tip-out angle	°	45	45	45	45
M	Tipping angle	°	45	48	45	48
-	Turning radius (over tyres)	mm	3,865	3,865	3,865	3,865

* Information: Dimensions refer to the standard equipment with standard bucket.

Load-bearing capacity diagram

8145T Load-bearing capacity diagram (with LSP 500mm)

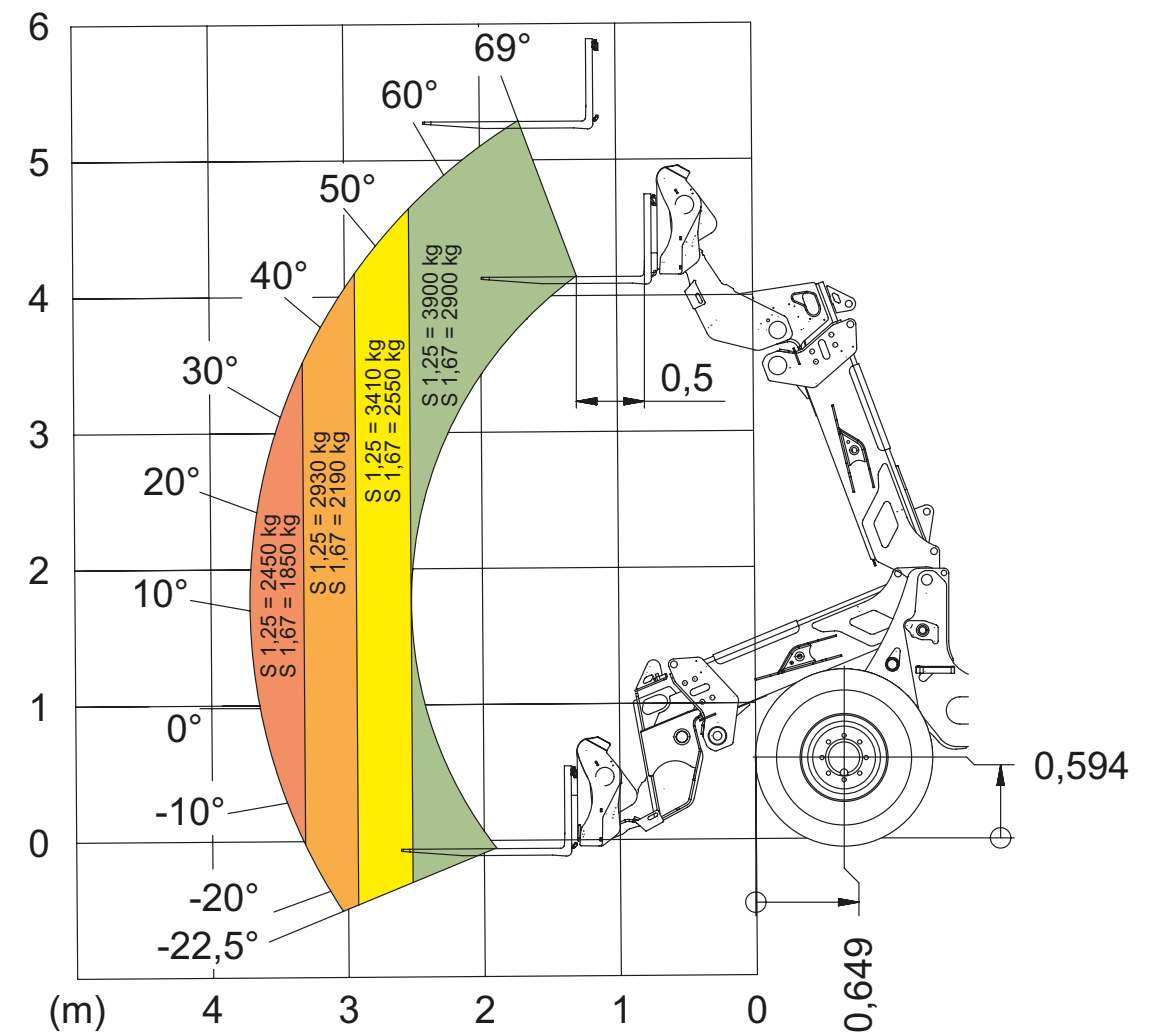



Wheel loader
Bucket capacity: 0.35 - 1.80 m³



telescopic wheel loaders
Bucket capacity: 0.65 - 1.45 m³



Telehandler
Payload: 1,200 - 5,500 kg

Service that can be seen

Focus on your daily activities – with our comprehensive services, we take care of the rest. We are there when you need us: capable, fast, and directly on site if necessary.



Repair & maintenance



Academy



Telematics



Insurance



Genuine parts



Financial Solutions



KC.EMEA.10288.V03.EN-GB