

GROUNDING TOP PERFORMER

The wheel loaders 5075/5085/5095



KRAMER
on the safe side



More equipment, more power

Discover the all-wheel drive wheel loaders in the 4 to 5 tonne class

The wheel loaders are suitable for application in small and large construction thanks to the combination of manoeuvrability and power. In addition to the engine version and the associated performance parameters, the standard equipment and the range of options were also designed for the construction industry's needs. The product range is rounded off by safety, comfort and a variety of options as well as an attractive selection of attachments, which allow for application year-round.



On the safe side with Kramer

Rich in tradition, the Kramer brand has been established on the market for many years and in particular stands for one value: **safety**. The high quality of the innovative machines is only one aspect of this. Kramer is also a safe choice as a company for customers and dealers, because its experience and innovative ability ensure secure investments and security for the future. In short – you are always on the safe side with Kramer: **“Kramer – on the safe side!”**

➔ **ON THE SAFE SIDE**

Table of contents

Vehicle structure

One-piece vehicle frame
Advantages at a glance
Types of steering

04

Machine components and accessories

Attachments, quick coupler system
Hydraulics
Loader units

08

Machine highlights at a glance

Engines
Drive
Hydraulics

12

Cabin concept

Set-up
Equipment
Operator's controls

14

Drive train and tyres

Engines
Drive system
Tyres

16

Technical Data and Dimensions

22

Operating and performance data	5075	5085	5095
Engine output [kW]	55.4	55.4	55.4
Bucket capacity [m³]	0.75	0.85	0.85
Bucket tipping load [kg]	3,400	3,700	3,800
Payload on pallet forks S=1.25 [kg]	2,000	2,250	2,350
Operating weight [kg]	4,200	4,610	4,714

Operational and performance data	5075L	5085L	5095L
Engine output [kW]	55.4	55.4	55.4
Bucket capacity [m³]	0.75	0.85	0.85
Bucket tipping load [kg]	3,300	3,050	3,150
Payload on pallet forks S=1.25 [kg]	1,900	1,900	2,000
Operating weight [kg]	4,290	4,693	4,800

Why split what belongs together?

Kramer – A unique system

The Kramer brand stands for all wheel steer loaders, telescopic wheel loaders and telehandlers with extreme manoeuvrability, all-terrain mobility and high efficiency. The wheel loaders impress with their high level of stability thanks to the time-tested and proven, one-piece vehicle frame.

Due to this special vehicle set-up, there is no shifting of the centre of gravity through steering movements. Only the wheels move when steering due to the Ackermann steering. Thus, high stability is given even with a tight turning circle, on uneven ground conditions and with maximum payloads.

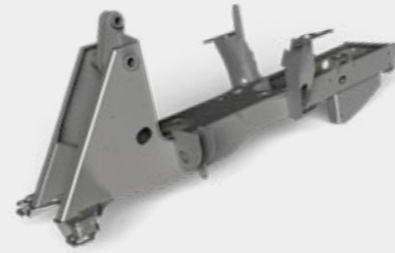

The benefits at a glance

High level of stability

The wheel loaders are designed with a one-piece chassis that prevents shifts in the centre of gravity – even with a full steering lock. This makes the vehicles with a high level of stability convincing – even in uneven ground conditions.

Enormous manoeuvrability

The all-wheel steering and the steering angle of 40 degrees on the front and rear axle allow you a high degree of manoeuvrability. Some steering manoeuvres therefore become unnecessary, resulting in shorter cycle times.

Constant payload

The undivided chassis prevents the distance between the counterweight and the loader unit from changing. The result: Constant leverage that makes working safe in all load situations. In the process, the payload always stays the same, independent of the steering angle.

Undivided chassis for a high level of stability...

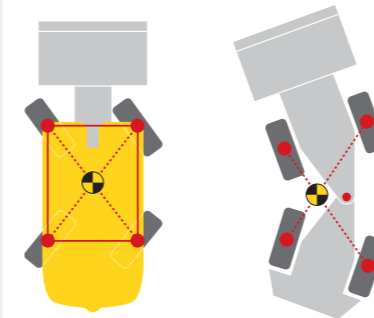

...without a shift in the centre of gravity.

Turning made easy with all-wheel steering...

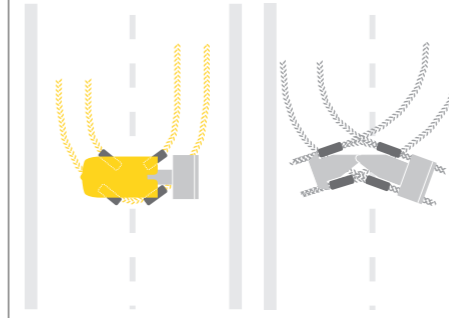

...instead of time-consuming manoeuvring with an articulated joint.

Constant leverage for constant payload

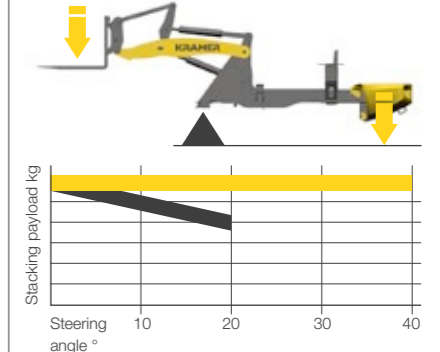

■ Kramer
■ Competition (articulated)

Flexibility in application

The right type of steering system for any application

The undivided vehicle frame forms the basis for three different types of steering. A wheel loader's design principle decides how it is used and for which application areas. The steering system is the crucial factor here.



All-wheel steering

- 2 x 40 degree steering angle on the front and rear axle ensure quick work processes
- Optimised routes
- Tight turning circle



Front wheel steering (option)

- Safe and familiar road travel at high speed
- Easy guidance of special attachments
- Familiar steering system
- Ideal for trailer operation

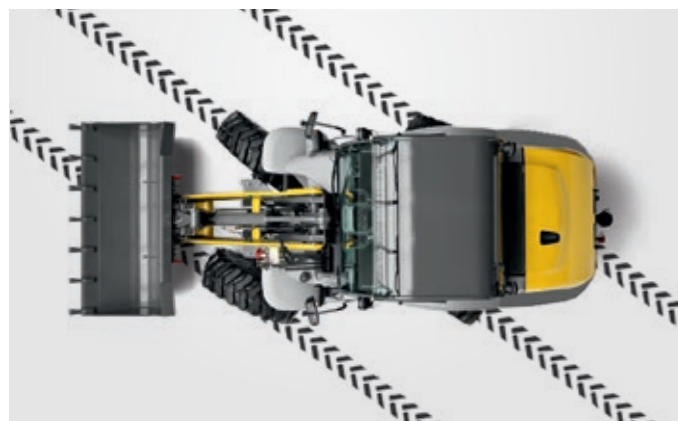

Crab steering (optional)

- Manoeuvrability in the smallest space
- Precise positioning in the tightest conditions
- Moving of special attachments
- Easily move away from walls and trenches



All-wheel steering is particularly manoeuvrable in tight spaces



Crab steering for precise positioning



Front axle steering for increased stability during quick transport trips

A variety of tasks











Always the right attachments

Regardless of what challenges your application holds for you: With the different attachments, you will always have a handle on the situation. Thanks to the hydraulic quickhitch system, you can adapt your Kramer wheel loader to any situation in no time. Standard attachments can even be changed in less than 10 seconds.

The attachment is based on your needs. You can find out more about our attachments at: www.kramer.de/attachments

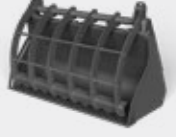

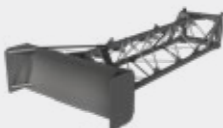
Product range of attachments

			
Pallet fork	Pallet forks fold-down	Pallet forks hydraulic parallel adjustment	Standard bucket with rip-out teeth
			
Standard bucket without rip-out teeth	Power grab bucket with rip-out teeth	Power grab bucket without rip-out teeth	Bulky goods bucket
			
Side tilt bucket	High tip bucket	Material slide	Load hook slip-on
			
Snowplough model A			

Exact specifications and availabilities of attachments vary by model and country. Your competent Kramer dealer will be happy to help you.

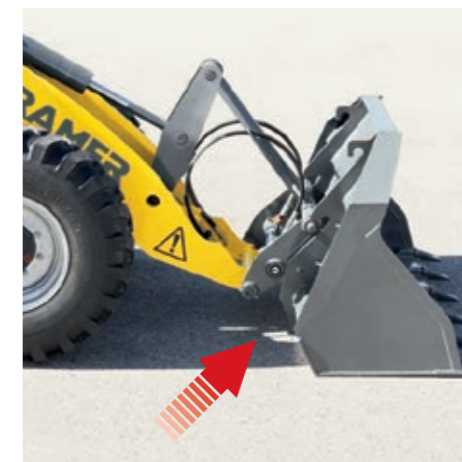

Hydraulic quick-change system - The Kramer quickhitch system: approach the attachment, pick up the attachment hydraulically from the operator's seat and lock it using the touch slide on the joystick. The lock cylinder is located outside of the pivot point of the quickhitch plate and is thus not in the contamination area.

Powerful work hydraulics

For precisely controlling the loader unit

Connect and disconnect different attachments, sensitive control, quick work cycles and all of this with a low noise level in the cab: the technology behind the work hydraulics of our machines makes this possible.

The work hydraulics are powered by powerful gear pumps, which ensure quick work cycles of the loader unit and allow for the operation of special attachments via the 3rd control circuit, if necessary with continuous function.

Pressure release of 3rd control circuit:

Easily couple and uncouple attachments with hydraulic additional function



Top performance of the work hydraulics:

- convenient operation of attachments with hydraulic functions, via the joystick
- hydraulically operated quickhitch plate time-tested and proven thousands of times with pressure relief for the 3rd control circuit
- Hydraulic oil cooler for the long-time application during power operation

Two loader units

Work easily with large loads

Depending on requirements, two different loader units are available. The standard and optional extended loader unit are both parallel-guided and ensure a consistent lift capacity as well as a safe operation during materials handling. Kramer offers a hydraulic quickhitch receptacle for this purpose with large bolts, which provide maximum load capacity. In addition, the automatic load stabiliser is optionally available. The load stabiliser dampens oscillations of the loader unit, providing optimal comfort for man and machine. The automatic function automatically switches on the load stabiliser after a speed of 15 km/h (transport operation) or automatically switches it off under 13 km/h (loading operation). In addition, it is possible to continuously enable or disable the load stabiliser for certain applications.

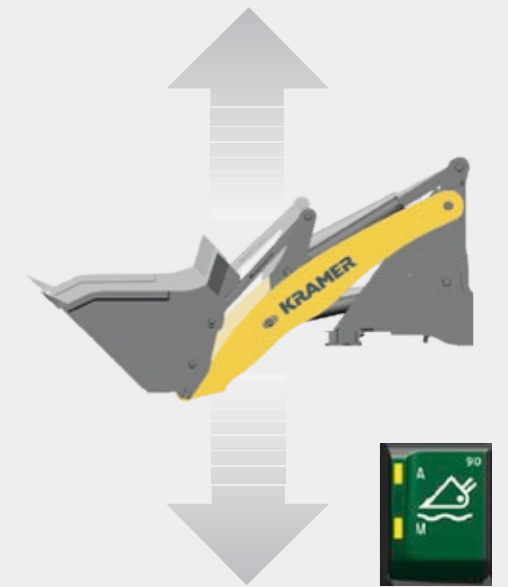

The load stabiliser dampens oscillations of the load unit, providing for improved ride comfort and increased driving safety.

Standard loader unit (P-kinematics)



The parallel-guided loader unit ensures constant lift capacity and a safe operation in materials handling. Due to the 50° high tilt back angle and the tilt-out angle of 45°, the wheel loader does not lose any material in bucket application, even when it is very full, allowing for a complete emptying of the bucket.

- Precise and safe working possible
- Loads are automatically kept level when raising and lowering
- High tear-out forces
- Precise parallel guidance over the entire lift height

Extended loader unit (P-kinematics)



Specific customer wishes can be met even more flexibly due to the extended loader unit. Among other things, the range, payload and lift height change compared to the standard loader unit.

- Optimal view of the quickhitch facility and the attachment
- Increased lift height and more reach
- Extended loader unit is optionally available

Machine highlights at a glance

Strong in every respect

The Kramer models shown are characterised by innovative technical equipment and powerful engines with exhaust emission stage V. A load hook on the tilt rod as well as an integrated visual position indicator for the bucket and pallet forks complete the extensive standard equipment. See for yourself!

Hydraulic quickhitch facility
with four connection points for the perfect seat of the attachment.

Extended loader unit with P-kinematics
offers more lift height with a simultaneously perfect view of the attachment.

Comfort cab
with extensive glazing for superb all-round visibility and fatigue-free working.

Excellent performance values
with compact dimensions and low dead weight.

Powerful engines by Kohler
with exhaust emission stage V,
high power delivery, low noise level
and 4 years / 4,000 hours warranty.

The standard loader unit with P kinematics
combines high lifting and tearout forces with exact parallel guidance over the entire lifting range.

Flexible in application
with a 3rd control circuit,
unpressurised return flow with
leakage pipe and front outlet.

Unique steering system
with three types of steering: all-wheel steering
(standard), front axle and crab steering (option).

Large selection of tyre options
for a wide range of application areas.

Wide and safe entry
thanks to the undivided chassis
and all-wheel steering.

Excellent traction
thanks to 100%
connectible differential
lock in the front axle.

Variable drive system
for sensitive work and
high pushing power
(optionally up to 30 km/h).

Standard and optional equipment

**Lubrication line for rear axle
pendulum pins (standard)**



Load hook on the tilt rod (standard)



Central lubrication strip (option)



Visual position indicator (standard)

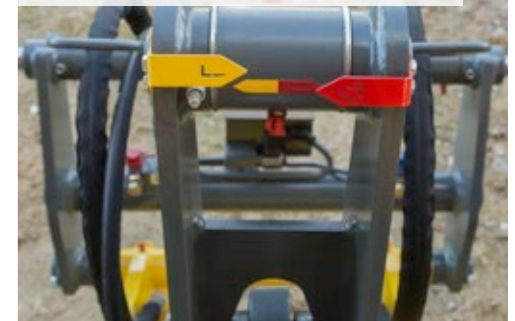

Comfortable working area

Thought out down to the last detail

From the operator's seat to the steering wheel, every detail is consequently adjusted to the operator's needs. The result is maximum comfort, optimal ergonomics and functionality. In addition, the large glass surfaces always give the operator an unobstructed view of the attachment.

The cabin is equipped with a rear-view mirror, a tilt-adjustable steering column, rear window heating as well as four work lights for better working at night. With the ergonomically shaped joystick, you can also work fatigue-free on long days. Additional options, such as a two-stage entry as well as an air-sprung operator's seat with heated seat, complete the offering.

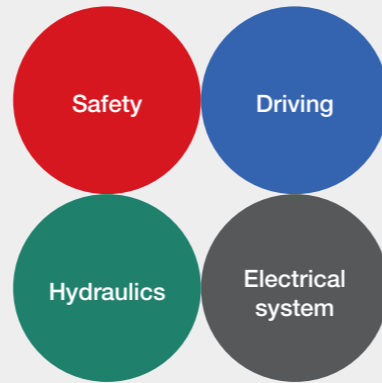

Colour-coding of the switches:
four colours for even more safety.



Very spacious and perfect visibility to all sides

Technical highlights

Simple operation – Innovative cabin design

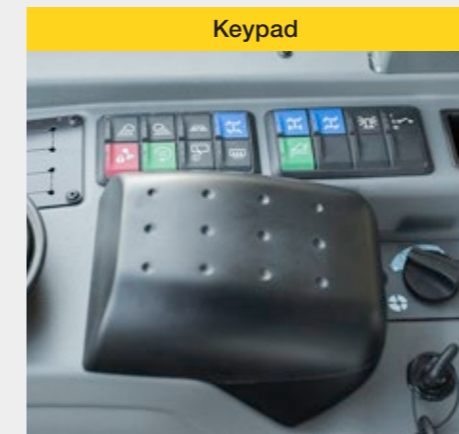

The respective functional group is very quick and easy to identify due to the colour-coded switches. Red = safety, green = hydraulics, blue = travel and grey = electrical system. This ensures the operator a convenient and safe operation without the risk of being confused. The result is increased working efficiency.

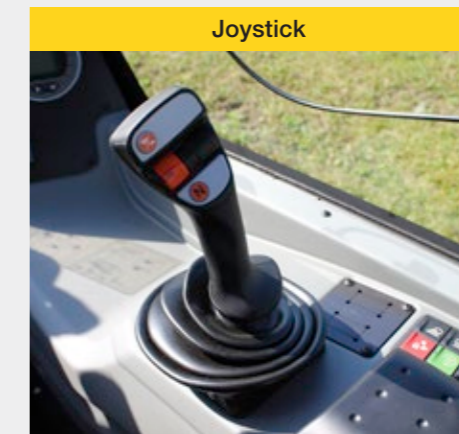

The ergonomically shaped joystick is securely integrated into the armrest and allows for sensitive and precise machine control. The speed selection is right on the joystick to increase the level of convenience. This makes it possible to switch over between the two speeds faster.

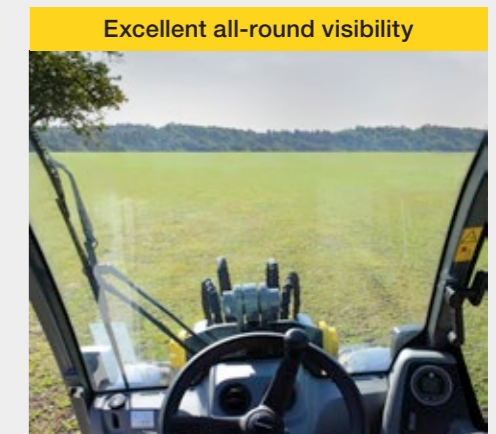

The central seat position in combination with the large glass windows offer a 360° all-round visibility. The particularly clearly-arranged design and the seat position of the operator avoid "blind spots". You can even see everything to the rear. The elevated front window allows for a perfect view of the attachment, even when the loader unit is raised.

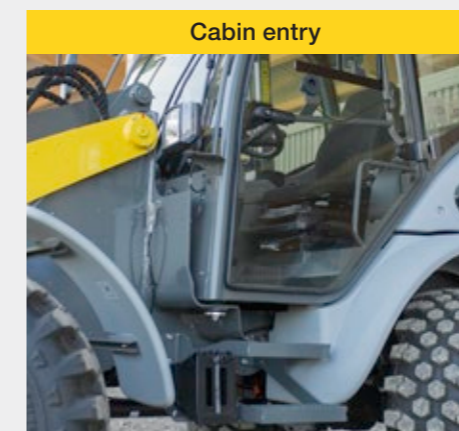

The cabin can be accessed through the large entry area. A two-stage entry is optionally available to give the operator an even more comfortable entry. In addition, the handles are in an ergonomically favourable position.

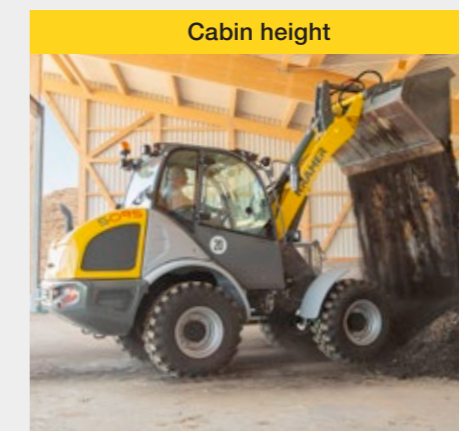

The compact and low design of the wheel loaders of less than 2.50 m allows for the ideal application of the machines in confined construction sites. The machines have the best prerequisites for low clearance heights thanks to their design.

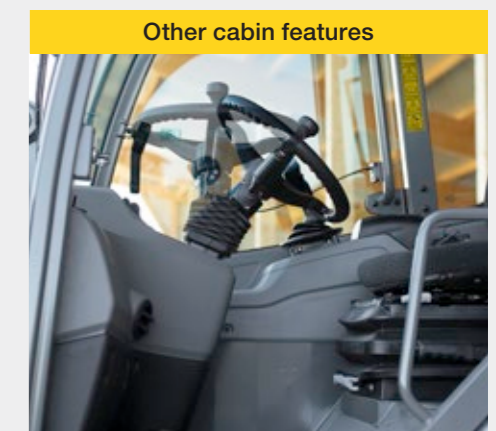

The extensive standard equipment includes, among other things, the tilt-adjustable steering column, which is individually adjustable. In addition, the rear-view mirror and the four work lights offer an optimal line-of-sight. The vehicle can optionally be equipped with an air-sprung operator's seat with lumbar support and a heated seat.

Powerful engines

Efficient and economical

You are well-prepared for strict exhaust standards with the engines of the Kramer wheel loaders. In addition to the modern exhaust technology, the engine also offers a high performance efficiency.

The installed 55.4 kW Kohler engine has a diesel oxidation catalytic converter (DOC) and diesel particulate filter (DPF) and meets emission level V. The engine offers full power despite the low rpm and offers a high torque rise. In addition, the manufacturer offers an engine warranty of 4 years or 4,000 hours.

Top performance of the engine:

- high-torque and economical Kohler engines with exhaust emissions stage V
- the latest exhaust aftertreatment with DOC + DPF
- 4 years / 4,000 hours warranty

Overview of engines	5075	5085	5095
Engine manufacturer	Kohler	Kohler	Kohler
Output [kw/hp]	55.4/74	55.4/74	55.4/74
Exhaust aftertreatment system	DOC+DPF	DOC+DPF	DOC+DPF
Exhaust fumes level (EU exhaust fumes standard)	Stage V	Stage V	Stage V

Exhaust fume aftertreatment systems

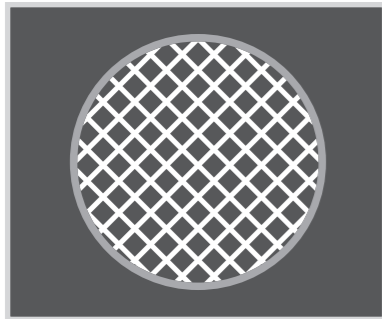

Diesel oxidation catalytic converter (DOC)

Catalytic converters are used these days to reduce emissions in many cars and lorries. The diesel oxidation catalytic converter has the same functionality. Without the movement of mechanical parts, it triggers chemical processes that reduce emissions.

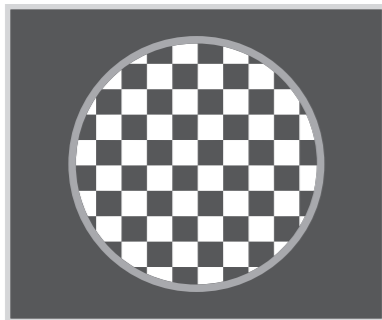

Diesel particulate filter (DPF)

The diesel particulate filter is used in connection with an oxidation catalytic converter to remove most of the nitrogen oxides, soot particles and non-combusted hydrocarbons from the combusted diesel fuel. The diesel particulate filter contains a porous honeycomb structure that catches the soot when it passes through. When the soot has accumulated to a certain extent, the machine's electronic system triggers fuel injections, which brings the non-combusted fuel into the oxidation catalytic converter, which is located before the filter. There it triggers an exothermic reaction that heats the exhaust fumes so much that the soot in the diesel particulate filter is combusted. This process is also known as regeneration.



Optimal running smoothness: economical and powerful engines in all Kramer models.

Performance curve Kohler KDI 2504 TCR; 55.4 kW; level V

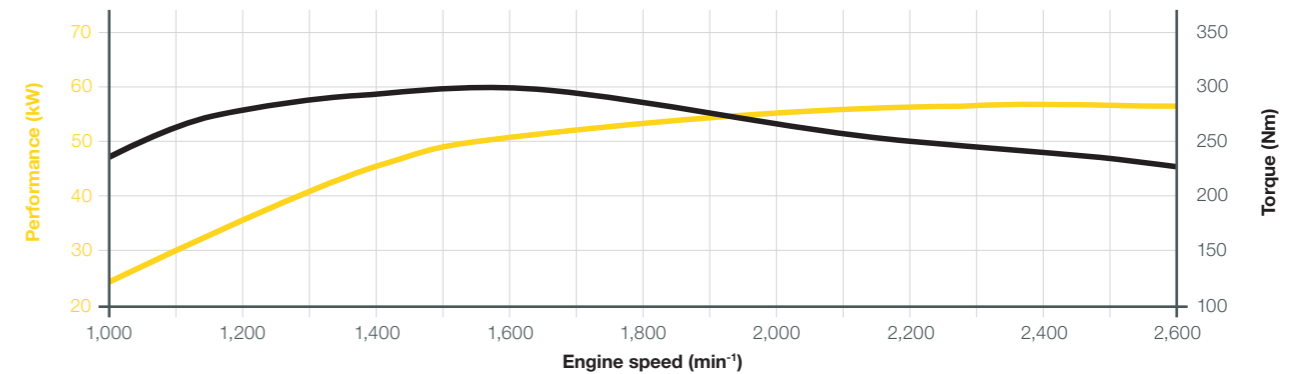

Variable power transmission

Reduced fuel consumption

A powerful drive system plus sophisticated safety and comfort features – with this combination, the Kramer wheel loaders score both on the go as well as on the construction site.

The infinitely variable axial piston transmission ensures powerful and stepless driving behaviour with a travel speed of 0-20 km/h. The variable power transmission allows for a sensitive control of the machine as well as positioning during machine handling. The wheel loaders are optionally equipped with a variable high speed of 0-30 km/h. You can travel from one site to the next faster with the high speed and save time.



Top performance of the drive system:

- maximum pushing power and tractive force in all driving and working situations
- Smart Driving - reduced fuel consumption
- sensitive, electronically-regulated drive system
- Constant Speed Drive (CSD) with memory function
- 100% connectible differential lock in the front axle for constant maximum traction



CSD - constant travel speed: supports compliance with the set speed, especially when running attachments where a consistent speed is required for the correct execution of the work process, such as: snowblower, rotary sweeper or mulcher.

Two freely selectable speed levels

The speed levels can be easily changed while driving. The change occurs conveniently through a switch on the joystick. The symbol is shown immediately in the central digital display.

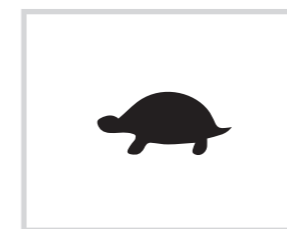

Turtle: 0 - 7 km/h

Available with
• Hydrostat

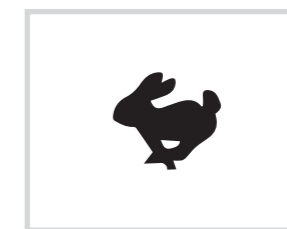

Hare: 0 - 20 (30 km/h)*

Available with
• Hydrostat
(maximum speed
20 or 30 km/h)

* High-speed engine

Smart Driving - RPM reduction

When the maximum speed is reached, the intelligent engine speed reduction "Smart Driving" adjusts the engine speed to the performance requirements of the traction drive. This minimizes noise, fuel consumption and the load on individual components. The diesel engine speed can be reduced to up to 2,000 rpm depending on the selected speed version.



Tread product range



- High running performance
- High level of traction
- Good mobility on soft ground
- Good self-cleaning

Construction machine tread - Mitas cross-ply tyres



- Good self-cleaning
- Ideal for loamy ground
- High level of traction
- High running performance

Traction tread - Michelin Radial tyres



- good track guiding
- high level of driving safety
- Good self-cleaning
- High running performance

Traction tread - Mitas Radial tyres



- Good winter serviceability
- High running performance
- Noise-optimised
- For applications on and off of the road

Municipal tread - Continental Radial tyres



- smooth running on the road
- good resistance
- well-suited in sand and gravel
- High level of traction

Municipal tread - Alliance Radial tyres



- good resistance
- smooth running on the road
- High level of traction
- For applications on and off of the road

Multi-purpose tread - Dunlop Radial tyres



- High lift capacity
- High level of traction
- Excellent stability and improved driving comfort
- High level of running smoothness

Multi-purpose tread - Michelin Radial tyres

Choosing the right tyres is crucial when it comes to using your wheel loader. Exact tyre specifications and availabilities vary by model and country. Your competent Kramer dealer will be happy to help you.



Top Performance

Extensive standard equipment

- Cab: rear-view mirror for the cabin, tilt-adjustable steering column, joystick, four work lights, rear heated window
- Visual position display for bucket and pallet forks
- Load hook on the tilt rod
- Lubrication line for pendulum pins
- And much more

Variety of options

- Front wheel and crab steering
- Cab: air-sprung seat, canopy version with heated rear window
- Central lubrication strip
- Tyres: Michelin 400/70 R18 Bibload, Michelin 340/80 R18 XMCL - Traction tread
- And much more

Work hydraulics

- Convenient operation of attachments with hydraulic functions, via the joystick
- Time-tested and proven hydraulic quickhitch plate with pressure release in the 3rd control circuit
- Hydraulic oil cooler for the long-time application during power operation

Engine

- High-torque and economical engines from Kohler with exhaust emissions level V
- The latest exhaust aftertreatment with DOC + DPF
- 4 years / 4,000 hours warranty

Drive

- Maximum pushing power and tractive force in all driving and working situations
- Smart Driving - reduced fuel consumption
- Sensitive electronically-controlled drive system
- Constant Speed Drive (CSD) with memory function
- 100% connectible differential lock in the front axle for constant maximum traction

Technical Data

Engine	Unit	5075	5085	5095
Make	–	Kohler	Kohler	Kohler
Type/Model	–	KDI 2504 TCR	KDI 2504 TCR	KDI 2504 TCR
Output	kW	55.4	55.4	55.4
Max. torque	Nm at rpm	300 at 1,500	300 at 1,500	300 at 1,500
Displacement	cm ³	2,482	2,482	2,482
Exhaust emission stage	–	EU stage V	EU stage V	EU stage V
Power transmission				
Unit	Unit			
Drive	–	continuously variable hydrostatic axial-piston gearbox		
Travel speed	km/h	20 (series) 30 (option)	20 (series) 30 (option)	20 (series) 30 (option)
Axles	–	Planetary steering axles		
Total oscillation angle	°	22	22	22
Differential lock	%	100% front axle	100% front axle	100% front axle
Service brake	–	Hydraulic disc brake		
Parking brake	–	mechanical disc brake		
Standard tyres	–	340/80-18 (12.5-18)	340/80-20 (12.5-20)	340/80-20 (12.5-20)
Steering and work hydraulics				
Unit	Unit			
Steering system functionality	–	Hydrostatic all-wheel steering with emergency steering properties front wheel steering (option), crab steering (option)		
Functioning of work hydraulics	–	Gear pump		
Steering pump	–	Gear pump via priority valve		
Steering cylinder	–	One steering cylinder per axle		
Steering lock max.	°	2 x 40	2 x 40	2 x 40
Work pump	cm ³ /rev	32	32	32
Max. flow rate of pump	l/min	68.4	68.4	68.4
Max. pump capacity optional	l/min	-	-	-
Max. pressure	bar	240	240	240
Quickhitch system	–	Kramer		
Pilot operation	–	Mechanical		
Pilot control of 3rd control circuit	–	proportional		

Technical Data

Kinematics	Unit	5075	5085	5095
Design system	–	P-kinematics	P-kinematics	P-kinematics
Lifting force calculation according to ISO 14397-2 mechanical/hydraulic	kN	30.1/33.8	35.4/42.9	34.8/42.8
Tearout force calculation as per ISO 14397-2	kN	30.5	42.7	41.1
Lift cylinder raising/lowering	s	4.2/2.5	6.0/4.0	6.0/4.0
Tilt in/tilt out tilt cylinder: (upper position of the loader unit)	s	2.0/2.6	2.7/3.3	2.7/3.3
Tilt-in/tilt-out angle	°	50/44	50/41	50/41
Tipping load (standard bucket) required/actual	kg	2,700/3,400	3,060/3,700	3,420/3,800
Tipping load (pallet forks)	kg	2,500	2,800	2,900
Payload (standard bucket)	kg	1,350	1,530	1,710
Capacities				
Unit	Unit			
Fuel tank	l	75	75	75
Hydraulic oil tank	l	50	50	50
DEF tank	l	-	-	-
Electrical system				
Unit	Unit			
Operating voltage	V	12	12	12
Battery/alternator	Ah/A	100/100	100/100	100/100
Starter motor	kW	2.2	2.2	2.2
Noise emissions*				
Unit	Unit			
Measured value	dB(A)	99.9	99.9	99.9
Guaranteed value	dB(A)	101	101	101
Noise level at the operator's ear	dB(A)	78	78	78
Vibrations**				
Unit	Unit			
Vibration total value of the upper extremities of the body	m/s ²	< 2.5 m/s ² (< 8.2 feet/s ²)		
Maximum weighted average effective value of acceleration for the body	m/s ²	< 0.5 m/s ² (< 1.64 feet/s ² ***) 1.28 m/s ² (4.19 feet/s ² ****)		

* Information: the measurement occurs as per the requirements of the standard EN 474 and the directive 2000/14/EC. Measuring station: paved surface.





*** On flat and solid ground with the corresponding driving style

**** Application in extraction under harsh environmental conditions

** Uncertainty of measurement such as stated in ISO/TR 25398:2006.

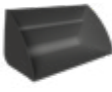
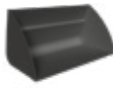
Please instruct or inform the operator of possible dangers caused by vibrations.



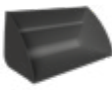

Technical Data



5075: Standard loader unit	Unit	Standard with rip-out teeth	Bulk material	Bulk material	Power grab bucket with rip-out teeth	Side pivot	High-tipping
							
Bucket capacity	m ³	0.75	1.05	1.15	0.65	0.75	1.06
Material density	t/m ³	1.80	1.40	1.20	1.80	1.60	1.20
Total length	mm	5,120	5,150	5,140	5,243	5,190	5,360
Bucket width	mm	1,850	2,050	2,150	1,750	1,844	1,850
Bucket swivel point	mm	3,100	3,100	3,100	3,100	3,100	3,100
Load-over height	mm	2,950	2,880	2,910	2,860	2,910	3,660
Dumping height	mm	2,400	2,290	2,300	2,340	2,250	3,600
Dump reach	mm	700	710	750	640	930	1,110
Scraping depth	mm	50	130	90	120	50	50
Operating weight	kg	4,200	4,299	4,323	4,385	4,393	4,426

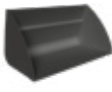
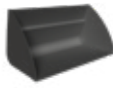

5085: Standard loader unit	Unit	Standard with rip-out teeth	Bulk material	Bulk material	Power grab bucket with rip-out teeth	Side pivot	High-tipping
							
Bucket capacity	m ³	0.85	1.15	1.30	0.75	0.75	0.87
Material density	t/m ³	1.80	1.40	1.20	1.80	1.80	1.60
Total length	mm	5,270	5,260	5,330	5,360	5,300	5,400
Bucket width	mm	1,950	2,150	2,150	1,850	1,844	1,850
Bucket swivel point	mm	3,350	3,350	3,350	3,350	3,350	3,350
Load-over height	mm	3,210	3,160	3,170	3,120	3,150	3,900
Dumping height	mm	2,680	2,580	2,500	2,600	2,530	3,840
Dump reach	mm	580	630	710	530	820	860
Scraping depth	mm	50	75	75	110	80	35
Operating weight	kg	4,610	4,720	4,725	4,798	4,790	4,775

5095: Standard loader unit	Unit	Standard with rip-out teeth	Bulk material	Bulk material	Power grab bucket with rip-out teeth	Side pivot	High-tipping
							
Bucket capacity	m ³	0.85	1.15	1.30	0.85	0.75	1.06
Material density	t/m ³	1.80	1.40	1.20	1.80	1.80	1.40
Total length	mm	5,270	5,260	5,330	5,370	5,300	5,490
Bucket width	mm	1,950	2,150	2,150	1,950	1,844	1,850
Bucket swivel point	mm	3,350	3,350	3,350	3,350	3,350	3,350
Load-over height	mm	3,210	3,160	3,170	3,120	3,150	3,910
Dumping height	mm	2,680	2,580	2,500	2,590	2,530	3,850
Dump reach	mm	580	630	710	540	820	960
Scraping depth	mm	50	75	75	110	80	35
Operating weight	kg	4,714	4,821	4,826	4,905	4,891	4,924

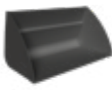
Technical Data

5075L: Extended loader unit	Unit	Standard with rip-out teeth	Bulk material	Bulk material	Power grab bucket with rip-out teeth	Side pivot	High-tipping
							
Bucket capacity	m ³	0.75	1.05	1.15	0.65	0.55	1.06
Material density	t/m ³	1.80	1.20	1.20	1.80	1.80	1.00
Total length	mm	5,280	5,210	5,270	5,405	5,250	5,360
Bucket width	mm	1,850	2,050	2,150	1,750	1,750	1,850
Bucket swivel point	mm	3,250	3,250	3,250	3,250	3,250	3,250
Load-over height	mm	3,100	3,030	3,060	3,030	3,170	3,880
Dumping height	mm	2,560	2,440	2,450	2,490	2,600	3,830
Dump reach	mm	680	700	740	630	800	890
Scraping depth	mm	70	130	94	130	70	60
Operating weight	kg	4,290	4,389	4,413	4,475	4,400	4,516

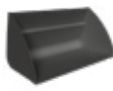
5085L: Extended loader unit	Unit	Standard with rip-out teeth	Bulk material	Bulk material	Power grab bucket with rip-out teeth	Side pivot	High-tipping
							
Bucket capacity	m ³	0.85	1.15	1.30	0.65	0.55	0.87
Material density	t/m ³	1.60	1.00	1.00	1.80	1.80	1.20
Total length	mm	5,580	5,560	5,630	5,660	5,530	5,700
Bucket width	mm	1,950	2,150	2,150	1,750	1,750	1,850
Bucket swivel point	mm	3,499	3,499	3,499	3,499	3,499	3,499
Load-over height	mm	3,360	3,320	3,320	3,270	3,350	4,020
Dumping height	mm	2,820	2,720	2,650	2,750	2,750	3,980
Dump reach	mm	790	840	920	740	970	1,090
Scraping depth	mm	50	90	90	120	50	35
Operating weight	kg	4,693	4,803	4,808	4,865	4,790	4,858

5095L: Extended loader unit	Unit	Standard with rip-out teeth	Bulk material	Bulk material	Power grab bucket with rip-out teeth	Side pivot	High-tipping
							
Bucket capacity	m ³	0.85	1.15	1.30	0.75	0.55	0.87
Material density	t/m ³	1.60	1.20	1.00	1.60	1.80	1.20
Total length	mm	5,580	5,560	5,630	5,660	5,530	5,700
Bucket width	mm	1,950	2,150	2,150	1,850	1,750	1,850
Bucket swivel point	mm	3,499	3,499	3,499	3,499	3,499	3,499
Load-over height	mm	3,360	3,320	3,320	3,270	3,350	4,020
Dumping height	mm	2,820	2,720	2,650	2,750	2,750	3,980
Dump reach	mm	790	840	920	740	970	1,090
Scraping depth	mm	50	90	90	110	50	35
Operating weight	kg	4,800	4,910	4,915	4,988	4,897	4,965

Dimensions

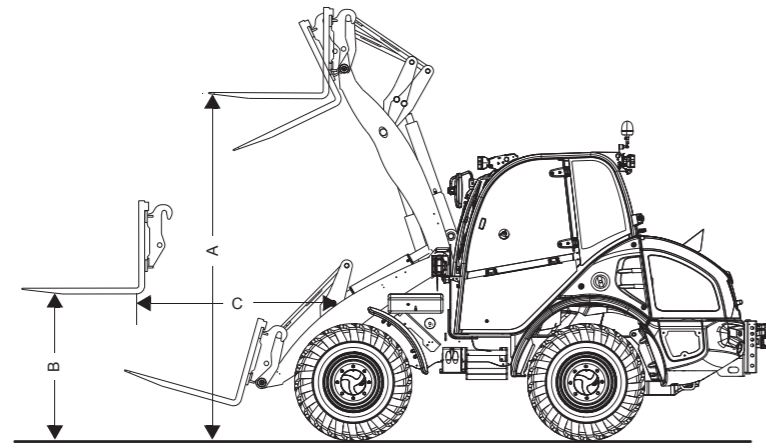

Pallet forks (load centre 500 mm)		Unit	5075	5085	5095
					
-	Width of the fork carriage	mm	1,200	1,200	1,200
-	Length of the fork tines	mm	1,000	1,000	1,000
-	Tipping load of pallet fork	kg	2,500	2,800	2,900
-	Stacking payload S=1.25	kg	2,000	2,250	2,350
-	Stacking payload S=1.67	kg	1,500	1,650	1,750
A	Stacking height	mm	2,840	3,150	3,150
B	Lift height, mast horizontal	mm	1,250	1,260	1,260
-	Scraping depth	mm	125	109	109
-	Ground reach	mm	690	770	770
C	Reach, mast horizontal	mm	1,090	1,170	1,170
-	Reach at max. height	mm	370	230	230

Pallet forks (load centre 500 mm)		Unit	5075L	5085L	5095L
					
-	Width of the fork carriage	mm	1,200	1,200	1,200
-	Length of the fork tines	mm	1,000	1,000	1,000
-	Tipping load of pallet forks	kg	2,375	2,400	2,500
-	Stacking payload S=1.25	kg	1,900	1,900	2,000
-	Stacking payload S=1.67	kg	1,400	1,400	1,450
A	Stacking height	mm	2,990	3,240	3,290
B	Lift height, mast horizontal	mm	1,260	1,260	1,260
-	Scraping depth	mm	125	110	110
-	Ground reach	mm	810	1,090	1,090
C	Reach, mast horizontal	mm	1,200	1,430	1,430
-	Reach at max. height	mm	360	400	400

Dimensions

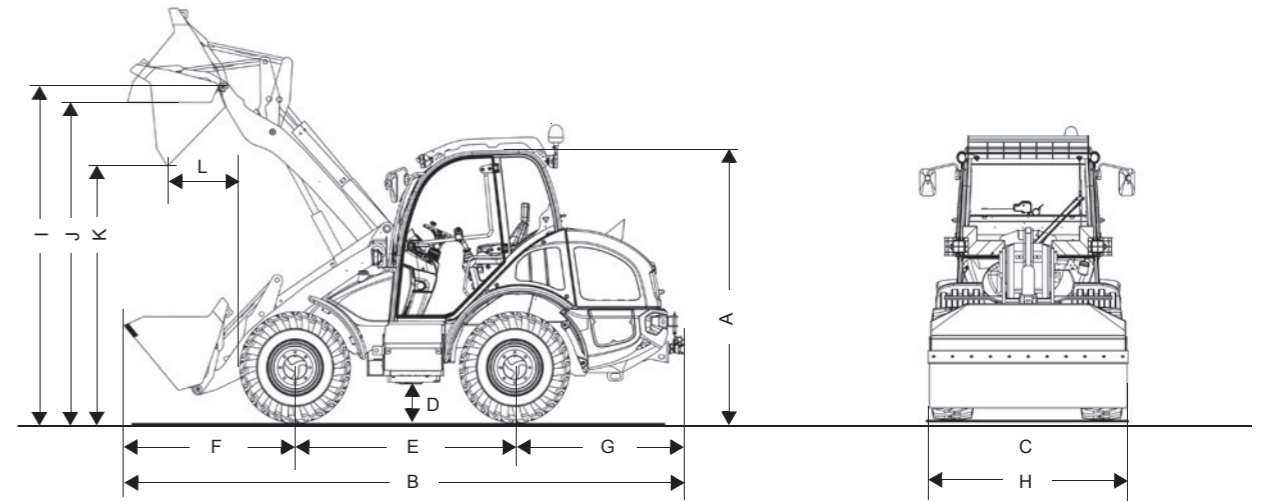

Standard equipment with standard bucket		Unit	5075	5085	5095
A	Height	mm	2,450	2,480	2,480
B	Length*	mm	4,490	4,640	4,640
C	Width*	mm	1,740	1,740	1,740
D	Ground clearance	mm	300	330	330
E	Wheel base	mm	2,020	2,020	2,020
F	Centre of front axle to tip of teeth	mm	1,730	1,860	1,860
G	Centre of rear axle to end of vehicle	mm	1,490	1,490	1,490
H	Bucket width	mm	1,850	1,950	1,950
I	Bucket swivel point	mm	3,100	3,350	3,350
J	Load-over height	mm	2,950	3,210	3,210
K	Dumping height	mm	2,400	2,680	2,680
L	Dump reach	mm	700	580	580
-	Stacking height	mm	2,840	3,150	3,150
-	Turning radius (over tires)	mm	2,840	2,840	2,840

Standard equipment with standard bucket		Unit	5075L	5085L	5095L
A	Height	mm	2,450	2,480	2,480
B	Length*	mm	4,640	4,920	4,920
C	Width*	mm	1,740	1,740	1,740
D	Ground clearance	mm	300	330	330
E	Wheel base	mm	2,020	2,020	2,020
F	Centre of front axle to tip of teeth	mm	1,890	2,190	2,190
G	Centre of rear axle to end of vehicle	mm	1,490	1,490	1,490
H	Bucket width	mm	1,850	1,850	1,850
I	Bucket swivel point	mm	3,250	3,499	3,499
J	Load-over height	mm	3,100	3,360	3,360
K	Dumping height	mm	2,560	2,820	2,820
L	Dump reach	mm	680	790	790
-	Stacking height	mm	2,990	3,240	3,290
-	Turning radius (over tires)	mm	2,840	2,840	2,840

* without attachment



Wheel loader
Bucket capacity: 0.35 - 1.80 m³



Telescopic wheel loaders
Bucket capacity: 0.65 - 1.45 m³



Telehandler
Payload: 1,200 - 5,500 kg

Service that can be seen

Focus on your daily activities – with our comprehensive services, we take care of the rest.
We are there when you need us: capable, fast, and directly on site if necessary.



Repair & maintenance



Academy



Telematics



Insurance



Spare parts



Financial Solutions



KC.EMEA.10201.V03.EN-GB