



**ATV / MULE**  
**2022**



**Kawasaki**  
Let the good times roll

# ***KAWASAKI MULE, BUILT STRONG TO WORK HARD***



# MULE PRO-MX

Delivering all the rugged, reliable and adaptable attributes that Kawasaki's MULE utility vehicle brand is justifiably famous for, the Kawasaki MULE PRO-MX range for 2022 relies not only on a torque laden 700cc CVT single-cylinder equipped engine, but also benefits from the Shinari design philosophy.

Like on the MULE PRO Series flagship models, an automotive-style dashboard puts all controls within easy reach. Digital instrumentation provides at-a-glance information

The PRO-MX offers a 317 kg (700 lbs) cargo bed capacity, and a 680 kg (1,500 lbs) towing capacity



Double-wishbone suspension is used both front and rear to enable each of the wheels to drive over obstacles with minimum effect on the chassis

Electrically "selectable" 1 2WD/4WD and dualmode rear differential system allow easy changing between drive systems to suit changing terrain and applications

## MULE PRO-MX TECHNICAL SPECIFICATIONS

<b>Engine type</b>	Liquid-cooled, 4-stroke Single	<b>Final drive</b>	Shaft 2WD/4WD
<b>Bore x stroke</b>	102 x 85 mm	<b>Suspension, front</b>	Independent double wishbone
<b>Compression ratio</b>	10.3:1	<b>Suspension, rear</b>	Independent double wishbone
<b>Maximum power</b>	32.8 kW {45 PS} / 6,000 rpm	<b>Wheel travel, front / rear</b>	218 mm / 232 mm
<b>Maximum torque</b>	57.6 N·m {5.8 kgf·m} / 5,000 rpm	<b>Brakes, front</b>	Dual 186 mm discs
<b>Fuel system</b>	Fuel injection: Ø44 mm x 1 throttle body	<b>Brakes, rear</b>	Dual 174 mm discs
<b>Ignition</b>	Battery & Coil (Transistorised ignition)	<b>Tyre size, front / rear</b>	25 x 8.00 R12 / 25 x 10.00 R12
<b>Starting</b>	Electric	<b>L x W x H</b>	2,795 x 1,525 x 1,890 mm
<b>Transmission</b>	CVT, 2 speed auto, reverse	<b>Colour</b>	Timberline Green
<b>EPS</b>	Electronic Power Steering		

# MULE PRO-MX

The Mule PRO-MX is ready to work as hard as you do. The Mule PRO-MX is built to take whatever comes its way thanks to a large-capacity, torquey single cylinder engine driving a selectable 2WD/4WD auto transmission. Wishbone suspension front and rear aids stability on tough terrain and 25 inch wheels roll over the roughest ground. A 36-litre fuel capacity gives the Mule PRO-MX a wide operating range. The centre console is ready to take an accessory audio system and there's a handy DC outlet. A reversing light, LED taillight and horn are useful safety additions.



## CHASSIS

Shinari is a Japanese term that describes the elasticity that enables an object to bend without breaking and return to its original shape – similar to how a hunting bow or fishing pole behaves.

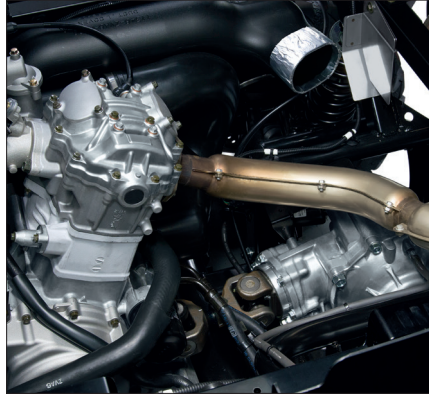

## ENGINE

In addition to offering plenty of towing and carrying capacity for hauling cargo at work, the highly reliable fuel-injected 700cc single-cylinder engine's superior torque contributes to a fun-to-drive character and facilitates lowspeed control.



## DIGITAL INSTRUMENTATION

Digital instrumentation provides at-a-glance information. And the centre console comes prepped for an accessory audio system.

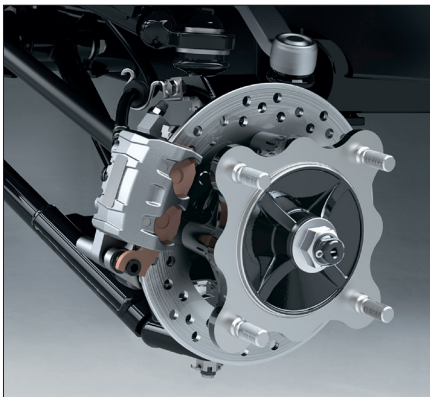

## BRAKES

Front and rear disc brakes ensure strong, sure stopping power – especially when combined with the engine braking. The hydraulic disc system offers predictable performance, delivering brake power that matches input at the brake pedal.

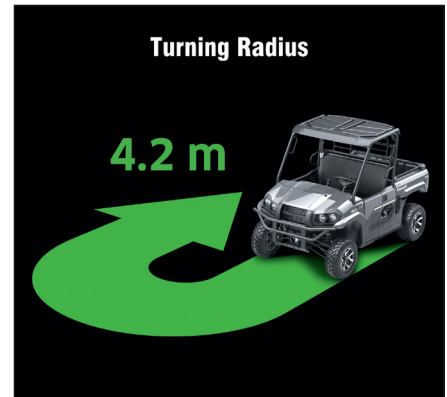
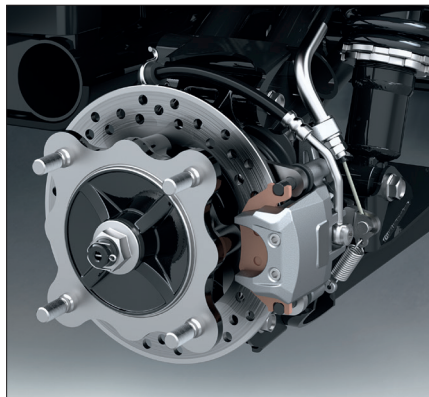

## TURNING RADIUS

Short 4.2 m (13.8 ft) turning radius makes it easier to negotiate tight corners in the woods or on trail courses.



## EPS

Kawasaki's high-grade electric power steering (EPS) system is speed sensitive, offering light steering at low speed, while reducing assistance as vehicle speed increases to tighten up the steering.



## CARGO BED AND TOWING CAPACITY

The PRO-MX offers a 317 kg (700 lbs) cargo bed capacity, and a 680 kg (1,500 lbs) towing capacity.



## ROOMY SEATING FOR TWO

Complementing ample shoulder, knee and legroom for two adults, the bench seat features contoured seating for both driver and passenger.





# MULE SX 4X4 FI

The MULE SX incorporates many features inspired by the PRO range in both function and style. Dependable four-stroke power from the 401cc engine combined with a 181 kg load and 500 kg towing capacity and 4-wheel drive make the MULE SX a true hard worker.



## MULE SX TECHNICAL SPECIFICATIONS

<b>Engine type</b>	401 cm <sup>3</sup> Air-cooled, OHV, 4-stroke single	<b>Final drive</b>	Shaft 2WD/4WD
<b>Bore x stroke</b>	82 x 76 mm	<b>Suspension, front</b>	Independent, MacPherson strut
<b>Compression ratio</b>	8.6:1	<b>Suspension, rear</b>	Unit swing arm with coil shock absorbers
<b>Maximum power</b>	9.9 kW (13.5 PS) / 4,000 rpm	<b>Wheel travel, front / rear</b>	78 mm / 79 mm
<b>Maximum torque</b>	29.0 N•m (3 kgf•m) / 2,400 rpm	<b>Brakes, front</b>	Dual hydraulic drums
<b>Fuel system</b>	Fi (Fuel Injection)	<b>Brakes, rear</b>	Dual hydraulic drums
<b>Ignition</b>	Battery & Coil (Transistorised ignition)	<b>Tyre size, front / rear</b>	24 x 9-10 / 24 x 11-10
<b>Starting</b>	Electric	<b>L x W x H</b>	2,710 x 1,335 x 1,800 mm
<b>Transmission</b>	CVT, 2 speed auto, reverse	<b>Colour</b>	Timberline Green

# MULE SX 4X4 FI

Durable and reliable, the MULE SX is your dependable working partner. Take the MULE SX wherever you need it thanks to compact dimensions and 4-wheel drive with 24 inch off-road tyres. A 16-litre fuel tank extends the operational range of the SX with its fuel-efficient and powerful 401cc four-stroke engine. Familiar automotive dashboard design ensures ease of operation while a host of features guarantee ride comfort and convenience.



## DASHBOARD

Drawing on the design of the PRO Series console, the dashboard puts all controls within easy reach and sight of the operator. Thick-grip steering wheel aids comfort.

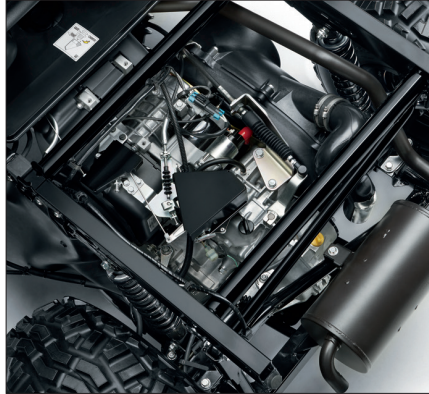

## ENGINE

The 401cc, four-stroke, OHV, air-cooled engine is compact, light, durable and delivers its power reliably and economically with a restricted top speed of 40 km/h (25 mph).



## CHASSIS

A tubular steel chassis provides the best balance of rigidity, strength and ride comfort. Independent front suspension and rack-and-pinion steering aid traction and handling.



## TILT STEERING

The PRO Series style thickly padded steering wheel can be tilted through 29° to suit operator preference and facilitate a quick and easy entrance and exit, making getting in and out of the MULE easier.



## CARGO CAPACITY

The easy-to-load tilting cargo bed can carry up to 181 kg of tools and materials while an additional 500 kg can be towed behind the ever-eager MULE.



## BIG WHEEL 4X4

The MULE SX 4x4 has large 24" off-road tyres making it even easier to tackle rough terrain. Hi-Lo dual range auto transmission with rear differential lock enhance traction.









# MULE PRO-DX

When there's serious work to be done the MULE PRO-DX is ready to take the load. High torque diesel power moves cargo and crew quickly with the safety assurance of Roll-Over Protection System (ROPS). On site or on the farm, the class-leading 453 kg capacity of the long and low tipping cargo bed and 907 kg towing potential makes light work of the heaviest tasks.



## MULE PRO-DX TECHNICAL SPECIFICATIONS

<b>Engine type</b>	993 cm <sup>3</sup> Liquid-cooled, 4-stroke Diesel, 3-cylinder OHV	<b>Suspension, front</b>	Independent double wishbone
<b>Bore x stroke</b>	74 x 77 mm	<b>Suspension, rear</b>	Independent double wishbone
<b>Compression ratio</b>	23.5:1	<b>Wheel travel, front / rear (left, right)</b>	222 mm / 217 mm, 220 mm
<b>Maximum power</b>	17.8 kW (24 PS) / 3,600 rpm	<b>Brakes, front</b>	Dual 212 mm discs with 2-piston calipers
<b>Maximum torque</b>	52.1 N•m (5.3 kgf•m) / 2,400 rpm	<b>Brakes, rear</b>	Dual 212 mm discs with 1-piston calipers
<b>Fuel system</b>	In-line injection pump	<b>Tyre size, front / rear</b>	26 x 9.00-12 4PR / 26 x 11.00-12 4PR
<b>Starting</b>	Electric	<b>L x W x H</b>	3,385 x 1,625 x 1,965 mm
<b>Transmission</b>	CVT, 2-speed auto, reverse	<b>Colour</b>	Timberline Green
<b>Final drive</b>	2WD / 4WD, shaft, Dual-Mode Differential		
<b>EPS</b>	Speed sensitive Electronic Power Steering		



**UNIQUE, PRACTICAL AND VERSATILE**

The innovative MULE PRO-DXT quickly changes from four to two seats in a few, swift moves that a single operator can manage in less than one minute.



# MULE PRO-DXT

For flexibility in demanding industrial and agricultural environments, the MULE PRO-DXT can be reconfigured to transport more staff or a greater payload. The Trans Cab system allows the rear bench to be raised or lowered in less than one minute. A three-cylinder diesel engine delivers the torque in 2WD and 4WD modes to move 453 kg loads or trailer up to 907 kg.

Conversion between two to four seats is quick and easy. There is no need for tools, the rear seat bench folding out of the way when it is not required

When carrying four people, the cargo bay reduces to a generous 560 mm in length



With the rear seats folded, the load bay is extended by 525 mm

Light at low speeds, power steering makes manoeuvring with a full load smoother and easier

## MULE PRO-DXT TECHNICAL SPECIFICATIONS

<b>Engine type</b>	993 cm <sup>3</sup> Liquid-cooled, 4-stroke Diesel, 3-cylinder OHV	<b>Suspension, front</b>	Double wishbone
<b>Bore x stroke</b>	74 x 77 mm	<b>Suspension, rear</b>	Double wishbone
<b>Compression ratio</b>	23.5:1	<b>Wheel travel, front / rear (left, right)</b>	222 mm / 217 mm, 220 mm
<b>Maximum power</b>	17.8 kW (24 PS) / 3,600 rpm	<b>Brakes, front</b>	Dual 212 mm discs with 2-piston calipers
<b>Maximum torque</b>	52.1 N•m (5.3 kgf•m) / 2,400 rpm	<b>Brakes, rear</b>	Dual 212 mm discs with 1-piston calipers
<b>Fuel system</b>	In-line injection pump	<b>Tyre size, front / rear</b>	26 x 9.00-12 4PR / 26 x 11.00-12 4PR
<b>Starting</b>	Electric	<b>L x W x H</b>	3,385 x 1,625 x 1,970 mm
<b>Transmission</b>	CVT, 2-speed auto, reverse	<b>Colour</b>	Timberline Green
<b>Final drive</b>	2WD / 4WD, shaft, Dual-Mode Differential		
<b>EPS</b>	Speed sensitive Electronic Power Steering		

# MULE PRO-DX / PRO-DXT

Working in tough environments demands durable, reliable machinery that continues to deliver in all conditions. A steel ladder chassis is ready for all terrains, strong where it needs to be and flexible where it matters. A three-cylinder diesel engine guarantees the torque needed to carry loads and crew reliably, hour after working hour. The rugged, hard-working styling of the MULE PRO-DX and PRO-DXT is not just there for show.



## ENGINE

The powerful 993 cm<sup>3</sup> three-cylinder diesel engine specified for the MULE PRO-DXT and PRO-DX delivers abundant low-speed torque for load-hauling and sufficient power to hit 30 mph (48 km/h).

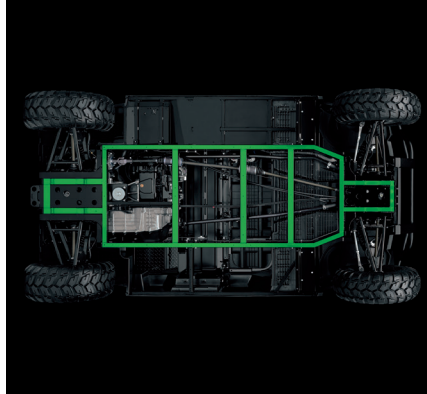

## FRAME

High-quality square-tube steel is welded and bolted together to ensure the performance and durability of the ladder-frame chassis. Extreme load areas feature high-tensile steel sections.



## ELECTRICALLY SELECTABLE 4WD & REAR DIFFERENTIAL LOCK

Changing terrain is no obstacle as the 2WD / 4WD and dual-mode differential can be switched electrically.



## ADJUSTABLE STEERING WHEEL

Different drivers can adjust the thickly padded steering wheel approximately 34 degrees to ensure comfort and control, or move it out of the way when entering or exiting the vehicle.



## TILTING CARGO BED

A flat bed made from 1.52 mm diamond-plate steel maximises available space and can be tilted on gas-assisted struts. The tailgate has a two-lever release system for easy opening and closing.



## LED LIGHTS

Night visibility and safety benefit hugely from the standard fitment auxiliary LED headlights (10.2/20.4W) on the MULE PRO-DXT and PRO-DX, complementing the main 55/60W units.









***KAWASAKI BRUTE FORCE,  
DRIVING YOU FORWARD***



# BRUTE FORCE 750 4X4i EPS

The Electronic Power Steering Brute Force 750 4X4i EPS marries a sturdy yet refined fuel-injected, water-cooled, V-twin engine with a 567 kg towing ability plus electronically selectable two/four wheel drive, the double wishbone front suspension is matched by an Independent Rear Suspension plus engine braking control.

## Colours



Super Black



Camo



## BRUTE FORCE 750 4X4i EPS TECHNICAL SPECIFICATIONS

<b>Engine type</b>	749 cm <sup>3</sup> Liquid-cooled, 4-stroke 90° V-twin	<b>Suspension, front</b>	Independent double wishbone with 5-way adjustable spring preload
<b>Bore x stroke</b>	85 x 66 mm	<b>Suspension, rear</b>	Independent double wishbone with 5-way adjustable spring preload
<b>Compression ratio</b>	9.3:1	<b>Wheel travel, front / rear</b>	169 mm / 190 mm
<b>Maximum power</b>	37.3 kW (51 PS) / 6,750 rpm	<b>Brakes, front</b>	Dual 200 mm discs with 2-piston calipers
<b>Maximum torque</b>	58.1 N•m (5.9 kgf•m) / 5,250 rpm	<b>Brakes, rear</b>	Enclosed wet multi-plate
<b>Valve system</b>	SOHC, 8 valves	<b>Tyre size, front / rear</b>	AT 25 x 8-12 / AT 25 x 10-12
<b>Fuel system</b>	Fuel injection: ø36 mm x 2	<b>L x W x H</b>	2,195 x 1,180 x 1,220 mm
<b>Ignition</b>	Battery & Coil (Transistorised ignition)	<b>Colours</b>	Super Black / Camouflage Real Tree Xtra Green
<b>Starting</b>	Electric		
<b>Transmission</b>	2-speed automatic with reverse		
<b>Final drive</b>	Shaft 2WD/4WD		
<b>EPS</b>	Speed sensitive Electronic Power Steering		

# ACCESSORIES



When it comes to those essential working extras, stay with Kawasaki for quality and durability. From cab kits to bed liners and hydraulic assistance to workshop overalls, your dealer is equipped to deliver quality and durability.

To see the full range of genuine accessories, visit the Kawasaki website or ask your authorised dealer.

## MULE PRO-MX ACCESSORIES



**SIDE MIRROR SET**



**CARGO BOX**



**HEADREST**

## MULE SX ACCESSORIES



**LED HEADLIGHT SET**



**WARN® PROVANTAGE™  
3500S WINCH**



**BACK-UP BEEPER**

## MULE PRO-DX / PRO-DXT ACCESSORIES



**QCR™ CARGO BOX**



**HEAVY-DUTY SPRINGS**



**TRAILER HITCH**

## BRUTE FORCE 750 ACCESSORIES



**ATV 110 LITER CASE (REAR)**



**ATV 40 LITER CASE (FRONT)**

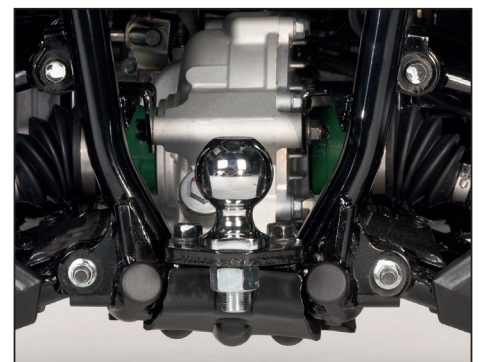

**TOW BALL (50MM)**

Always operate vehicles responsibly. Respect the law and the environment. Always operate vehicles within the limits of your skills, your experience, and your machine. Wear approved apparel including protective clothing. Adhere to the instructions and maintenance schedule in your owner's manual. Never drink and operate machinery. Specifications have been achieved by production models under standard operating conditions. Data are intended to describe vehicles and their performance capabilities fairly but may not apply to every machine. Specifications likely to change without notice. Specifications, data and illustrated equipment may vary by market and are subject to alterations. Kawasaki Motors Europe NV does not accept liability for any alteration or typing error. The actions depicted here took place under controlled conditions with professional operators. Never attempt any action which is potentially dangerous. The images/photographs shown in this "ATV/MULE 2022" Brochure are only meant as a reference. They may display accessories and features not fitted as standard or available only for the products within the US market.

The K-Care valuable customer programmes are available exclusively for products officially imported by Kawasaki Motors Europe NV and sold through its official network.

**Copyright © 2021 Kawasaki Motors Europe N.V.**  
All image rights reserved.



#### **Kawasaki Motors U.K.**

1 Dukes Meadow  
Millboard Road  
Bourne End  
Buckinghamshire  
SL8 5XF

01628 856750

For more information, please visit [www.kawasaki.co.uk](http://www.kawasaki.co.uk)

